

DOCUMENT RESUME

ED 341 629

SO 021 927

AUTHOR Oltman, Debra L.
 TITLE Pennsylvania Classroom Guide to Safety in the Visual Arts.
 INSTITUTION Pennsylvania State Dept. of Education, Harrisburg.
 PUB DATE May 90
 NOTE 143p.; Cover title is "Hazards: Pennsylvania Classroom Guide to Safety in the Visual Arts."
 AVAILABLE FROM Pennsylvania Department of Education, 333 Market Street, Harrisburg, PA 17126-0333.
 PUB TYPE Guides - Non-Classroom Use (055)

EDRS PRICE MF01 Plus Postage. PC Not Available from EDRS.
 DESCRIPTORS Adhesives; *Art Education; *Art Materials; Ceramics; Child Health; Elementary Secondary Education; Handicrafts; *Hazardous Materials; *Health; Instructional Materials; *Safety Equipment; School Safety; *Visual Arts
 IDENTIFIERS Pennsylvania

ABSTRACT

Exposure to certain art materials can damage the human body. Some of these materials are identified together with factors that influence exposure, including duration, frequency, and environmental conditions. Responsibility for providing a safe working environment for the creation of visual arts in the classroom lies with the instructor, principal, administration, and school board. Factors to consider for the safe use of equipment and facilities include general facility maintenance, art material storage and clean up, personal safety equipment, and ventilation. Specific recommendations for the safe use of art materials are organized under 10 sections for adhesives, ceramics, drawing and painting, enameling, glass, metals, photography, print-making, sculpture, and textile arts. Each of these sections is presented in three parts: (1) hazards and precautions; (2) levels of materials usage (teacher, senior high, junior high, or elementary); and (3) a safety checklist. The document concludes with safety data sheets for each art section, a list of addresses for additional safety information, a glossary, a quick reference guide to safety equipment icons, and a 19-item bibliography. (KM)

 * Reproductions supplied by EDRS are the best that can be made *
 * from the original document. *

ED341629

U.S. DEPARTMENT OF EDUCATION
Office of Educational Research and Improvement
EDUCATIONAL RESOURCES INFORMATION
CENTER (ERIC)

This document has been reproduced as
received from the person or organization
originating it.
 Minor changes have been made to improve
reproduction quality.

• Points of view or opinions stated in this docu-
ment do not necessarily represent official
OERI position or policy.

"PERMISSION TO REPRODUCE THIS
MATERIAL IN MICROFICHE ONLY
HAS BEEN GRANTED BY

CLYDE
MCGARY

TO THE EDUCATIONAL RESOURCES
INFORMATION CENTER (ERIC) "

HAZARDS

Pennsylvania Classroom Guide To Safety In The Visual Arts

Feb 21 1977

Pennsylvania Classroom Guide To Safety In The Visual Arts

by Debra L. Oltman

Pennsylvania Department of Education 1990

Commonwealth of Pennsylvania
Robert P. Casey, *Governor*

Department of Education
Donald M. Carroll Jr., *Secretary*

Office of Basic Education
Joseph Bard, *Commissioner*

Bureau of Curriculum and Instruction
Irvin T. Edgar, *Director*

Division of Arts and Sciences
Clvde M. McGeary, *Chief*

Edited by
Joseph B. DeAngelis, *Arts in Education Adviser*

Reviewed by Michael McCann
Center for Safety in the Arts, New York, NY

Illustrations by
Debra L. Oltman

Authored by
Debra L. Oitman

Pennsylvania Department of Education
333 Market Street
Harrisburg, PA 17126-0333

May 1990

The Pennsylvania Department of Education, an equal opportunity employer, will not discriminate in employment, educational programs or activities, based on race, color, religion, national origin, sex, age, ancestry, physical handicap or union membership. This policy of nondiscrimination extends to all other legally protected classifications. Publication of this policy in this document is in accordance with state and federal laws including Title IX of the Education Amendments of 1972 and Sections 503 and 504 of the Rehabilitation Act of 1973. Inquiries should be directed to Susan Mitchell, Affirmative Action Officer, 503/504 Coordinator, Education Building, 333 Market Street, Harrisburg, PA. 17126-0333 (717-787-1953). For additional copies of this publication, please contact Joseph B. DeAngelis (717-783-6745).

TABLE OF CONTENTS

FOREWORD	v
Scope of publication	v
Disclaimer	v
VISUAL ARTS SAFETY	1
Hazards, What Hazards?	1
How Art Materials Damage the Human Body	1
Factors That Influence Exposure	3
Individuals with Special Needs	4
RESPONSIBILITY: POLICIES, PROCEDURES, AND THE LAW	5
A Safe Work Environment	5
What Does the Law Say?	5
Who Has Jurisdiction?	5
Labeling and Product Safety Information	6
Responsibility of the Superintendent and School Board	7
Responsibility of the Administrator and Principal	8
Responsibility of the Teacher	8
The District-Wide Safety Plan	9
Approaches to Change for the Teacher	10
THE SAFE USE OF EQUIPMENT AND FACILITIES	12
General Facility Maintenance	12
Art Material Storage	13
Cleanup of Art Materials	15
Personal Safety Equipment	15
Breathing Easier: Ventilation	18
THE SAFE USE OF ART MATERIALS IN THE CLASSROOM	20
Adhesives	23
Ceramics	26
Drawing and Painting	34
Enameling	44
Glass	50
Metals	58
Photography	72
Printmaking	80
Sculpture	92
Textile Arts	106

SAFETY DATA SHEETS	112
CERAMICS / GENERAL	113
CERAMICS / EQUIPMENT	114
COMMERCIAL ART.....	115
DRAWING MATERIALS.....	116
ENAMELING.....	117
GLASS / GLASSBLOWING	118
GLASS / STAINED GLASS	119
METALS / CASTING.....	120
METALS / CLEANING AND FINISHING.....	121
METALS / OXYACETYLENE WELDING	122
METALS / SOLDERING	123
PAINTING.....	124
PAPERCUTTER	125
PHOTOGRAPHY	126
PRINTMAKING / INTAGLIO	127
PRINTMAKING / RELIEF.....	129
PRINTMAKING / SILKSCREEN	130
SCULPTURE / CARVING AND FINISHING.....	131
RESOURCES.....	134
California State Department Health Services - Product Listing	134
Educational Materials.....	134
General Safety Supply	134
Government Agencies	134
Labels	135
Organizations - Health Hazards and Art Materials	135
Organizations - Standards.....	135
Ventilation Equipment	135
GLOSSARY.....	136
BIBLIOGRAPHY.....	138
QUICK REFERENCE GUIDE - SAFETY EQUIPMENT ICONS	139

FOREWORD

Scope of Publication

The focus of this work is safety in the K-12 art classroom. This publication is to be used by art teachers, classroom teachers, and administrators to improve safety practices in the educational context.

This publication does not include information on the performing arts (theater, music, dance) or media arts. It should be noted, however, that many safety hazards exist when working in these other arts areas. In particular, any educator working with arts programs should examine with care, the hazards of using media including make-up, paints, solvents, developers, electrical equipment, etc.

These pages do not serve as a medical reference; specific medical problems should be directed to an appropriate health professional such as a physician who is board certified in occupational medicine.

As local regulations and codes vary, safety professionals, environmental specialists, ventilation experts, etc. should be consulted to develop safety plans for a full range of classroom facilities.

Technical information on specific products, is beyond the scope of this work; such requests for technical information and Material Safety Data Sheets should be directed to the manufacturer. Read all product safety information with care and comply with all safety instructions. If safety instructions are incomplete request additional information.

Disclaimer

The information contained in this publication has been compiled to provide educators with current and reliable information concerning visual arts safety in the classroom. These guidelines represent the best current information available on this subject. The author and the Pennsylvania Department of Education take no responsibility for the completeness or absolute correctness of the information in this publication. The author and the Department of Education also absolve themselves of responsibility for any misuse of the information herein.

Dedication

*To those teachers
and creators of art,
who brought joy to others
while endangering themselves.*

VISUAL ARTS SAFETY

Hazards, What Hazards?

The public is becoming more aware of hazards in the everyday environment, both in their homes and in their communities. Work related hazards for many materials have been well documented and extensive safety programs exist in industrial settings.

Many educators, however, including some art teachers, are still not aware of the hazards related to working with visual arts materials. Initially, such safety information can be overwhelming to the educator, due to its quantity. But taken in perspective, hazards can be controlled, and in many cases eliminated, through comprehensive safety planning.

All educators should be aware of the hazards of working with visual arts materials in the classroom. Legal action is possible against educators and educational institutions; the fixing of such problems should be addressed immediately for both legal and moral reasons.

The hazards of visual arts materials range from the obvious concerns related to power tools, burns, etc., to the less apparent hazards such as solvent or kiln fumes. If materials cannot be eliminated from an art process, teachers and students must work with them safely.

Some educators have panicked at the thought of meeting safety standards; they say: "we will lose our program; this community won't fund such equipment requests", or "I'm not so anxious to push for safety equipment and supplies because we may end up losing jobs in our department." Such concerns are in most cases extreme. Many industrial arts and science programs have voluntarily complied with standards recommended by the federal Occupational Safety and Health Administration (OSHA) or other regulations, without sacrificing program or staff. I have found in talking to educators in these other curriculum areas that they appreciate, and are proud of changes made to improve safety in their classroom environments.

Some educators are concerned that the imposing of a safety program on the visual artist will remove the aesthetic component from the visual arts studio experience. On the contrary, a safety program for the visual artist will enhance and possibly extend the life of the visual artist. There is nothing aesthetic about getting a migraine or coughing for a couple of hours after working with a visual arts material.

Safety issues - those causing injury, and health issues - those causing illness will be examined below.

How Art Materials Damage The Human Body

A poison is a substance which enters the body in a quantity that exceeds the body's capacity to handle the material. Water could kill someone if taken in too large an amount. Poisons are directly related to individual susceptibility. Many art materials are poisonous.

Toxins enter the body through three main channels: skin contact, inhalation, and ingestion. In addition, it is noted that toxins can be injected into the body.

Some chemicals cause damage by being absorbed through the skin. Direct damage to the skin can be the result of cuts, abrasions, etc. When the skin has been damaged materials can be absorbed more readily.

Corrosives, irritants, and other chemicals can cause damage in the form of allergic dermatitis, skin cancer, and internal diseases. Though dermatitis and skin allergies often give us an indication that there is a problem, many chemicals that cause damage to the body by entering through the skin, are not easily identified by general observation. Methanol for example, which is found in most schools in the ditto fluid, is absorbed through the skin and then it enters the blood stream.

Eye damage is most often associated with objects entering the eye, or liquids being splashed into the eyes. But eye diseases can be the result of other types of exposure as well. An eye disease, such as conjunctivitis, can be the result of working with carbon arc lamps or arc welding. Corneal damage or blindness can result from working with polyester resins. Infrared rays from kilns or furnaces can provoke cataracts when working without eye protection. Contact lenses can also pose problems for the wearer if dust or solutions such as acids come in contact with them.

Inhalants enter the body through the respiratory system. Airborne chemicals that have a high solubility in water tend to damage the upper respiratory tract (throat, bronchi) while those not as soluble affect the lower respiratory system (lungs, air sacs). Some chemicals affect both upper and lower respiratory systems. Such effects may be chronic or acute.

Common examples of art materials which damage the respiratory system include sulfur dioxide gas from kiln emissions, the gases from nitric acid etching baths (which can cause pulmonary edema and emphysema), the sulfur dioxide emitted from black and white photo chemicals, and silica from clay dust. With particulates, the finer the particulate (airborne spray or airbrush paint vs. paint in a can or a tube) the more toxic its effects on the body.

Acute respiratory diseases related to toxins include pulmonary edema (water in the lungs), pneumonia, asthma and hayfever, hypersensitivity pneumonia, and metal fume fever (particularly with zinc or copper fumes).

Chronic respiratory diseases related to toxins in art materials include chronic bronchitis, emphysema, pneumoconiosis (pulmonary fibrosis, silicosis, black lung, etc), byssinosis (brown lung), and lung cancer.

The ingestion of chemicals often seems to be simply a matter of poisoning, most often associated with children. However, there are other ways in which chemicals can be transferred to the mouth and ingested. Through eating, drinking, and smoking in the work area, chemicals settle on the materials and are transferred to the mouth or swallowed. The pointing of brushes with the lips allows all the materials on the brush to enter the body. With improperly cleaned hands, chemicals enter the body when eating, drinking, or smoking. These chemicals then affect the mouth, throat, gastrointestinal system, the liver, etc. To avoid ingestion hazards, be sure not to use things associated with food, such as glass jars and plastic containers, to store art materials.

Sensitizers such as poison ivy promote skin allergies or allergic contact dermatitis in susceptible individuals. Some art materials that are sensitizers include photo developers, turpentine, formaldehyde, epoxy, and certain wood varieties.

For carcinogens (cancer-causing chemicals), there is no known safe level of exposure. Therefore carcinogens should not appear in the visual arts experience.

Factors That Influence Exposure

The major factors that influence exposure to chemicals are listed below:

1. the duration of exposure
2. the conditions of exposure
3. the length and frequency of exposure
4. the total body burden
5. multiple exposures
6. being a member of a high risk group

Exposure duration and conditions of exposure are important factors in determining individual risk. Most government safety standards for "safe" levels of chemical exposure have been formulated for the eight-hour work day. Many art teachers are exposed to toxins during the work day and often return to their homes or studios for additional exposure with art materials. It should be noted that it can take up to 16 hours for the body to detoxify and excrete many chemicals. In a home setting, round the clock exposure can occur to all family members. Many artists/educators must change the way they think and the way they work in order to reduce personal risks.

Chemical interactions can cause even greater problems. These interactions can be additive or synergistic. An additive effect occurs when two different substances attack the same part of the body. For example, turpentine and alcohol both attack the central nervous system, and the combined effect is the sum of the two separate exposures.

In a synergistic interaction, the combined effect of chemicals is far more damaging than either individual material. This multiplying effect can produce devastating results, such as from the combination of alcohol and barbiturates. The combination of smoking and particulates is a concern to many artists and educators. Many of these effects are unknown and therefore risks should be reduced or eliminated whenever possible. Remember, these combined effects can occur as the result of exposures in different environments, such as the school and a second job or the home.

The total body burden is the cumulative effect of separate exposures to a chemical. When this cumulative effect exceeds the body's capacity to detoxify the material, injury can occur.

High risk groups are those individuals who tend to be more susceptible to toxins. For example, smokers and drinkers are more likely to be affected by chemicals. Other high risk groups include pregnant women, individuals with previous health problems, and individuals over the age of 65. Some people may be more susceptible to chemicals because of high stress or heredity.

Many materials that do not affect adults are harmful to children, especially young children. Educators using visual arts materials should place great emphasis on safeguarding them. Children are at high risk because of: the quick absorption of chemicals into the body, incomplete immune defense systems, low body weight, and potential damage to growing tissues. Their small lung passages are very susceptible to inflammation and spasms. Rapidly growing tissues in children are very easily damaged by poisons or the lack of oxygen or nutrients.

Children under 12 need special monitoring to carry out appropriate safety procedures on a consistent basis.

Individuals With Special Needs

The mainstreaming process has brought many students with special needs and abilities into the regular classroom. The instructor must be aware of these special needs and appropriate safety precautions for these individuals.

In many cases, these students cannot understand appropriate safety practices because of their handicap. Such individuals often have high hand/mouth contact, thus increasing the potential for ingestion problems.

Many individual physical problems also involve special safety precautions for the educator. Hearing impaired students working in a noisy sculpture studio probably need hearing protection. An individual with hepatitis (liver damage) should not be exposed to any solvents. The visually impaired tend to work very close to their projects, which can increase exposure. Individuals with asthma should not be exposed to dust or sensitizers. Someone who has epileptic seizures should not work with materials such as solvents. In addition, medications combined with such materials can cause problems.

Safety planning for individuals with special mental and physical needs must involve the appropriate health personnel. The educator may need to contact the school nurse, the student's doctor, or other special education instructors in order to obtain all pertinent information.



RESPONSIBILITY: POLICIES, PROCEDURES, and the LAW

A Safe Work Environment

The responsibility for providing a safe work environment for the creation of visual arts in the classroom lies with the instructor, principal, administration, and school board.

District guidelines for safe operations should parallel liability coverage. Protection for liability problems for art activities in the educational setting should be secured by school districts and individuals. Individual coverage is available through numerous professional state and national education associations and organizations.

What Does The Law Say?

Under the doctrine of *respondeat superior*, a school district can be charged for the wrongful acts of its employees. Teachers stand *in loco parentis to the students*; they are legally accountable for the consequences of student conduct. Teachers are obligated to exercise **reasonably prudent** care toward their pupils according to the circumstances. This reasonable care includes warning students of dangers, and appropriate training related to the use of tools or equipment. Teachers are responsible for the supervision of all activity in the classroom. Qualley (1986) presents major factors related to legal liability and the art teacher in his text, *Safety in the Artroom*, which was produced as part of a National Art Education Association effort.

School districts' tort liability is related to its ownership and the wrongful use of property. Therefore, both the teacher and the school district are responsible for students in the art classroom.

Teachers are urged to exercise the "utmost" precaution in all classroom experiences. Precedents for negligence specifically related to art teachers, and illness or injury related to the art classroom were not found as of this printing.

Who Has Jurisdiction?

No one particular group is responsible for monitoring, maintaining, or regulating safety standards in the schools. Numerous technical standards are available which were primarily developed for industrial facilities. Most of these standards and recommendations are applicable to studio settings in the school, though it must be remembered that such industrial standards were not planned for use by children, who are far more readily affected by toxins. Several agencies and standards related to hazardous materials are cited below:

ANSI : American National Standards Institute

This organization sets standards for safety equipment , etc.; these standards are used by OSHA.

CPSC : Consumer Product Safety Commission

This federal agency regulates consumer products and their labeling. Art materials, especially in small quantities, often have incomplete precautions on the labeling.

EPA : Environmental Protection Agency

Agency given authority by the Toxic Substances Control Act (TSCA).

NFPA : National Fire Protection Association

This organization sets standards for materials related to fire hazards including flammables and combustibles, chemical storage, fire extinguishers, etc.

NIOSH : National Institute of Occupational Safety and Health

This division of the Department of Health and Human Services researches health hazards for OSHA and evaluates workplaces upon request (including requests made by teachers).

OSHA : Occupational Safety and Health Administration

The Occupational Safety and Health Act of 1970 was designed to "assure safe and healthy" working conditions. As Pennsylvania does not currently have a state (OSHA) plan, OSHA does not protect federal, state or municipal workers (including teachers); thus public school teachers are not protected by OSHA. If you have OSHA rights, working in a private school, exercise them!

The Pennsylvania Worker and Community Right to Know Act

This act requires that information on hazardous substances be provided by employers to "workers, the general public and emergency service organizations." A classroom is exempted from certain sections of the act as a "research and development laboratory." In addition, since students are not considered employees under the Act, student notification is not required although it is encouraged as an example of worklife preparation. Employers are, however, still responsible to employees under the Act. Major elements of the Act that apply to schools include the annual training of appropriate staff (including art teachers), filing of Material Safety Data Sheets (MSDS), and the proper labeling of hazardous substances.

TSCA: Toxic Substances Control Act

The purpose of this act is to provide for the pretesting of chemicals before being released on the market. It should be noted that all chemicals are not required to be tested.

Information is available to all citizens from the agencies cited above. Appropriate addresses can be found in the resource section of this publication.

Labeling and Product Safety Information

In order to develop appropriate safety practices, it is essential that the individual know exactly what substances are in art materials. Until the passage of the "Art Materials Labeling Act" (H.R. 4847) by the U.S. Congress on October 19, 1988, it was rare for product labels to list all ingredients.

The labeling requirements of the act become effective on October 19, 1990. The act requires that manufacturers of art and craft materials determine if their products have the potential to cause chronic illness and to place labels on those products that do. Manufacturers and repackagers must also provide the Consumer Product Safety Commission (CPSC) with the criteria used to determine the hazards. New information about chronic hazards of an art material must be included on the label within 12 months of discovery.

Under the labeling act, the CPSC may require a warning on the label, or a package insert with warnings if there is a potential for chronic adverse health effects from normal use of the product. The act requires that all chronically-hazardous art materials carry a statement that these materials are inappropriate for children, and that the purchase of these materials for use by children in grade six and below be prohibited.

The term "non-toxic", used on many art materials, can be misleading. The Federal Hazardous Substances Act (FHSA) regulates the use of the term non-toxic. The law identifies acutely toxic products for adults (not children). Chronic hazards, cancer-causing potential, risk for children, and other sensitivities are not included in the testing. Many foreign products in particular, and some domestic products are improperly labeled as non-toxic.

Currently, AP (Approved Product) and CP (Certified Product) and HL (Health Label) are labels found on products which are certified by the Arts and Crafts Materials Institute (ACMI). They are labeled in accordance with the voluntary chronic hazard labeling standard ASTM D-4236. A limited number of products are voluntarily tested.

The California State Department of Health Services has conducted extensive testing of art materials; its list of approved products is the most comprehensive list currently available.

Another important source of information on product safety is the Material Safety Data Sheet (MSDS). The Pennsylvania Worker and Community Right to Know Act requires that MSDS sheets be made available to employees by employers. An MSDS may include information on industrial standards, health standards, fire hazard information, chemicals with which the product may react dangerously, and other information. Educators should require MSDSs as part of the bid/ordering procedures for all products purchased by schools.

Responsibility of the Superintendent and School Board

A thorough safety program in the visual arts includes responsibilities for the superintendent and school board.

School districts are responsible for the personnel, curriculum, facilities, and budget, all items which affect a school safety program.

A policy statement should be devised and adopted by the school board which delineates the district commitment to safety education and accident prevention. The formal adoption of this document is suggested within the individual district. The superintendent is responsible to the board for implementation of such a policy and guidelines. The superintendent and the staff should make extensive use of safety guides, publications and statutes.

A safety coordinator should be appointed for the school district. A written job description should identify the functions and responsibilities of the position. This individual should work with all appropriate staff to maintain safety standards. Plans for inservice training should be developed on a regular basis by the safety coordinator.

Separate funding for the safety program should be provided to insure implementation. Safety supplies and equipment repair should be budget priorities. A safe environment for the students and teacher cannot be compromised. Teachers should not be required to make choices between basic supply needs and safety needs when completing the annual budget.

Responsibility of the Administrator and Principal

A thorough safety program in the visual arts includes responsibilities for the building administrator and/or the principal.

The principal/ administrator should provide leadership and secure support for the safety program both inside and outside of the school. A department head may be delegated responsibilities for the safety program, but ultimately, the principal is responsible for administering it. Qualified community members should be identified to serve as resources.

As an administrative link to the district administration, the building administrator/principal should secure approval for the building safety plan and the related budgetary support for the program. Unsafe conditions which cannot be resolved at the building level should be reported immediately in writing to the district administration.

In conjunction with the district safety coordinator, a program in safety education should be developed. Training for teachers in accident prevention and first aid and the use of fire equipment should be planned. Staff should be selected who are knowledgeable of safety procedures and practices.

Safety instruction for students should be part of each course, both in the written curriculum and in the functioning of the course. Class size should be appropriately scheduled in order to assure student safety. Procedures for removal of students who violate safety rules must be established as such individuals are safety hazards.

Responsibility of the Teacher

A thorough safety program in the visual arts includes responsibilities for the teacher working with visual arts materials.

Implementation of a district-wide safety plan is ultimately the responsibility of the teacher in the visual arts. Safety instruction should be incorporated in each course of study. Documentation concerning to whom and when such instruction was given is important. Such instruction should present the potential hazards and safety guidelines for every art process. Documentation should include dated safety quizzes. An example of such quizzes appears later in this publication (see p. 133). Safe accommodations for individual needs, especially those of special students with handicaps (see p. 4) or health problems must be planned.

Specific safety rules and regulations for the facility must be developed and enforced. No student should work with an art process who does not have knowledge of proper safety procedures. No student is to remain working with art materials in the classroom who ignores safety procedures. The instructor should constantly update these safety practices. Any teacher who wishes to make an alteration in the district safety policy and guidelines, should receive permission to do so in the form of a written waiver.

The instructor must insist that proper personal protective equipment, including eye protection, respirators, gloves, aprons, and other suitable protective clothing be worn for studio experiences. Ventilation systems and other safety equipment are to be used as appropriate. Teachers must set an example by not eating, drinking, or smoking when art materials are being used.

Substitute teachers who are unfamiliar with art processes or specific pieces of equipment should not use these materials with students. Teachers cannot monitor the safe use of art materials and equipment if they are unfamiliar with safety practices and emergency procedures.

Safe housekeeping processes must be developed to maintain a safe studio. Machinery and the facility must be adequately maintained; a regular review of equipment, tools, storage, and the room help to prevent accidents. Recommendations to administrators should be made (in writing) to improve safety conditions.

Emergency procedures must be pre-planned. Written accident reports should always be filed when an accident occurs.

Students should always be supervised when in the classroom, especially in the visual arts classroom.

The District - Wide Safety Plan

A comprehensive health and safety program includes the cooperation of teachers, administrators, students, maintenance personnel, and purchasing agents for the school. Other advisory personnel from outside the school also are appropriate resources.

Written policy and safety guidelines should be adopted by the individual school district, creating a district-wide plan. Employees and advisory personnel contribute to formulating and adopting such standards and emergency procedures. Teacher training, planning, student instruction, enforcement of the plan, and adequate records are significant components for successful implementation of the safety plan.

Permission to deviate in any way from the district-wide safety plan should be obtained in writing from the safety coordinator and administration. For example, the purchase of a new expensive ventilation system will enable you to do color print development with your advanced photography students. The written waiver should indicate: 1) that the use of color chemistry will be limited to the specific building and place where the ventilation system has been installed, 2) that a specific type of color chemistry will be used only when the ventilation system is operating properly, 3) what particular students in what courses will be using the materials in question, 4) what are appropriate safety instructions for the students, and 5) a rationale for needing to use the particular process.

Each school should have written emergency procedures which include information related specifically to arts materials and equipment. Emergency procedures should specify general information such as fire drill procedures (who calls, etc.) and specific art emergency procedures such as those related to solvent or acid spills. The instructor should know the local poison control number and how the network functions.

A formal inspection of studio facilities should be completed on a regular basis; written reports should be a part of this process. A checklist is a reasonable solution. Written reports should follow all accidents and any near misses. Many schools require such reports to be filed (on a specific form) which include student information, location of accident, time and date of accident, injury description, location of instructor at time of accident, equipment involved, and witnesses (with dated signatures).

Approaches to Change for the Teacher

The problems in the art room must first be recognized by a teacher, safety coordinator, administrator, or other individual. Unfortunately too many problems are corrected as the result of an accident, i.e., the guard is put on the paper cutter after an incident involving a student. Through a safety plan, the careful monitoring of safety by responsible staff, and the proper training of students, accidents can be avoided.

The first concern of many art teachers discussing safety is often "the elimination of the best part of the program." This issue is not as traumatic as one might think. Often, creative alternatives or alterations to program activities arise as a result of concerns for safety. After a problem is recognized, numerous solutions can lead to the elimination or reduction of art hazards. These solutions and strategies related to implementing safety practices and to obtaining safety equipment will be examined below.

First, the educator must ask if the activity is appropriate to the age group. If so, is the material and equipment being used appropriate to the age group?

Second, when a problem arises, the educator should decide if the problem can be eliminated by substituting the least toxic material for the process. District bid lists should be revised to eliminate as many hazardous substances as possible. Materials approved by the California State Department of Health should be used in elementary programs while those with low toxicity can often be substituted in junior high art programs. A greater number of materials used in high school art programs for more specialized activities involve safety problems; therefore, the issue of safety is often a more difficult one to resolve in high school programs.

Household items such as hair dryers, which create sparks, may be inappropriate for classroom use when solvents are being used. A teacher must comprehensively plan all activities in a safe manner, analyzing possible health and safety problems. If hazards are unknown, a material should not be used.

Third, when materials require the use of safety equipment, the educator must examine the appropriate channels for resolving the problem. A building art teacher is often the individual to initiate changes in safety equipment and practices related to art. The problem must be approached in a factual and responsible manner in order to gain support for program changes, or financial support for expenditures related to the alteration or addition of facilities and/or the purchase of safety equipment.

The teacher should establish the chain of command for resolving problems within the district. Consultation with the district safety coordinator (if one exists) is a good step in formulating a solution to a safety problem.

Elimination of other safety hazards and a commitment to a safety program by the teacher shows an administrator a commitment to classroom safety. A principal will be more willing to "go to bat" for a safety program involving expenditures when he or she sees that the flammables are no longer being stored in the cabinet under the enameling kiln.

The teacher should identify who influences decision-making within the building, at the district level, and on the school board. Gaining the support of such decision-makers is often the key to unlocking the door to carefully guarded funds and coveted work time by district employees.

The resolving of safety issues in the art room is a group problem. Safety issues, plans, and resolutions should be documented and distributed to appropriate personnel. Keep the staff well informed of both progress and problems.

The school nurse, maintenance personnel, teachers in adjoining rooms, and other staff, in addition to the classroom teacher and administrator, can contribute greatly to the development of a safety plan and its implementation. External sources of support are available to the educator, parents, the PTA, and community health workers. These external sources often provide the support to see that the plan is accomplished.

A district-wide plan to improve safety in the visual arts is a more viable approach than a single building plan. Uniformity of program and practices and a safety plan will set a framework for consistent safety reform. Expenditures for equipment and facilities may be more readily attained through a line-item in the district's annual budget as opposed to finding an allocation in a building budget.

Once a general plan for safety has been established, call the experts. Consultants are available from groups such as the Center for Safety in the Arts (CSA) in New York City. CSA will conduct health hazard surveys for schools and other facilities where art is taught. As technical solutions are put in order of priority, experts will be needed to design equipment and facilities appropriate to the setting. The teacher or building custodian should not be responsible for designing specialized facilities or safety and ventilation equipment.

Many teachers are concerned with their health as a result of extended exposure to all kinds of chemicals over a period of many years. Medical referrals for a suspected exposure to toxic substances should be directed to a physician who is board certified in occupational medicine. Keep comprehensive records related to any suspected work-related illness.

THE SAFE USE of EQUIPMENT and FACILITIES

General Facility Maintenance

All art facilities and equipment in the classroom should be in good repair. The following general items should frequently be checked:

Studio cleanliness: A clean studio is a safer studio. Scrap materials, supplies, and equipment should have designated storage spaces. See to it that students understand the importance of a clean work space and that they keep the work space clean. Flammables should be stored properly.

Room layout: It is important to provide adequate space between pieces of stationary equipment and student work spaces. At least 3 feet of space should be planned between these work areas. Floors should not be slippery; non-slip adhesive tapes are appropriate for placement at the base of power equipment work stations and other suitable areas.

Room assignment: An assigned room for art is necessary in order to resolve hazards issues. Elementary art teachers, for example, may be responsible for "living off of a cart." It is much more difficult, if not impossible, to implement a comprehensive safety plan for visual arts in 20 different classrooms. Note that children in such a situation often eat and drink in the regular classroom spaces as well.

Classes other than art should not be scheduled in an art classroom because other educators have not been trained in the safe use of facilities and equipment.

Lighting: Is the lighting adequate for the visual arts activity? Frequently, ceiling fixtures do not give appropriate illumination for detail work. Check this item as new activities are added to the program.

Plumbing: Adequate plumbing facilities should be provided for cleanup procedures. Immediate access to running water is a safety feature necessary in any classroom where art materials are being used.

Ventilation: Appropriate ventilation, designed for specific classroom art activities, will eliminate toxic fumes and vapors (see details below).

Climate control: Equipment involving heat such as kilns, furnaces, and welding equipment may create an uncomfortable and unhealthy atmosphere. Air conditioning, fans, and ventilation systems can help to alleviate the problem. In addition, facility layout or the isolation of an activity may provide viable solutions.

Signage: Instructional information regarding safety and the visual arts should be posted with equipment or tools. Signage is no substitute for proper instruction. Extensive signage systems are available from many industrial safety supply companies (see resources).

The occasional changing of sign positions will draw more attention to the information contained on them. Examples might include:

1. No Food or Drink Permitted in the Studio.
2. No Smoking or Open Flames Permitted.
3. No Flammables Allowed.
4. Danger: Kiln Firing/Cooling
5. Flammables Storage Area
6. Wear Goggles When Working With this Material
7. Wear Gloves When Working With This Equipment
8. No Students Permitted in this Area
9. Caution: Welding Area
10. Caution: Acid Area

General protective equipment in the classroom should include fire extinguishers appropriate for the art materials and equipment used in the classroom. Sprinkler systems and smoke detectors are also appropriate safety systems for the visual arts classroom.

General first aid equipment in the classroom should include a first aid kit, fire blanket, and a readily available list of emergency telephone numbers.

Art Material Storage

The proper storage of art materials is fundamental in a visual arts safety program. All art materials should be properly labeled and stored. Fundamental guidelines are listed below:

1. Flammable and combustible liquids should be stored in accordance with local fire regulations. Approved flammable storage cabinets and safety containers are the appropriate equipment to be used. No sources of heat or sparks should be allowed near the flammables storage areas.
2. Place hazardous materials in unbreakable containers whenever possible.
3. Store hazardous materials in low-level cabinets where it is less likely they will fall.
4. Label all materials in the work space. Unidentified materials should be properly discarded.
5. Keep containers storing reactive chemicals separate from one another (e.g. acids and ammonia).
6. All gas tanks should be properly secured. Store and handle vertically.

Storage equipment for flammables and combustibles, and their corresponding uses are found on the next page.

STORAGE EQUIPMENT FOR FLAMMABLE AND COMBUSTIBLE LIQUIDS



CABINET FOR STORING
FLAMMABLE LIQUIDS

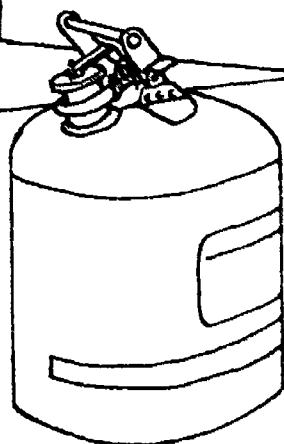

SAFETY CAN



DISPOSAL CAN

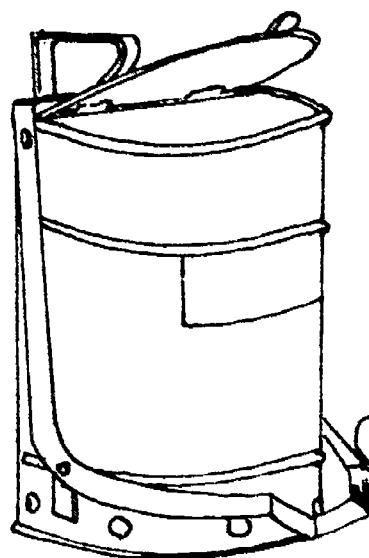

SELF-CLOSING
OILY WASTE
DISPOSAL CAN



Clean-Up of Art Materials

Often simple, safe clean-up procedures are as important as safe storage and working procedures. Important items related to proper clean-up are listed below:

1. Self-closing waste disposal cans should be used to dispose of rags, paper towels, or newspapers used with flammable or combustible liquids. Empty these containers using special waste handling procedures.
2. Neutralize any small amount of material such as acid before dumping it down the drain. Care must be exercised not to pollute the ground water in the community.
3. Solvents which are not water soluble should not be disposed of in the sink.
4. For disposal of large amounts of solvents, check to see if your school district has access to a waste disposal service for the disposal of toxins.
5. Dusts should be cleaned up with a vacuum, or preferably, a wet mop. Sweeping creates additional hazards and should be avoided.

Personal Safety Equipment

Protection for the eyes, hands, respiratory system and other parts of the body are essential to many art processes. When toxic materials are used in the general classroom space, it is necessary to provide safety equipment for all students. For example, students carving and refining plaster should be required to wear protective goggles; flying chips can be dangerous. Extensive safety equipment materials and equipment checklists are provided later in this publication.

In the case of isolated activities, safety equipment may only be necessary when working within that specialized area of the room, for example, a spray booth. In such cases, the teacher must carefully monitor other students who may wander into these areas. Safety instructions should guard against such activity.

Goggles, face shield, dust mask, aprons, and other protective clothing may be necessary equipment for the art student and teacher in the classroom. The proper equipment must be matched for the activity. For example, many types of gloves are available on the market; while one glove may be suited for oil based printing inks it may not be acceptable for working with acids or other solutions.

Activities requiring students to wear respirators are not recommended. The fitting of a respirator is difficult. The use of respirators requires delicate control and technical training for the wearer. In addition, individuals with beards or a small face (children, young adults) cannot be adequately protected with the use of respirators. From a liability perspective, the use of respirators is also a touchy situation. Michael McCann, of the Center for Safety in the Arts, said that the only situation where he might see the use of respirators in schools would be in a vocational education setting where each student has his/her own equipment and is using it for training in preparation for a particular trade. Such training should be extensive.

Therefore, for the art student, respirators should not be used for safety procedures in the educational setting . The teacher may find it necessary, especially in mixing solutions, to wear a respirator.

PERSONAL SAFETY EQUIPMENT

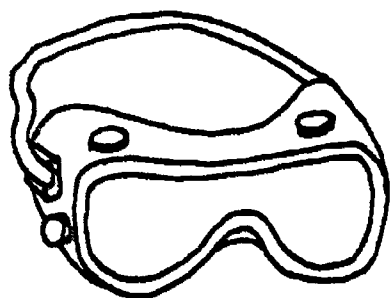

GOGGLES

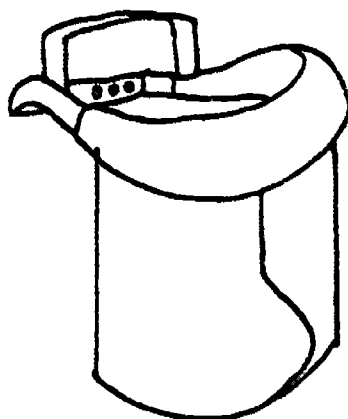

FACE SHIELD

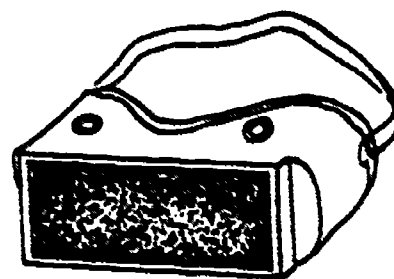

WELDING GOGGLES

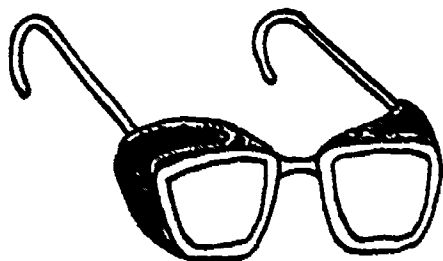

SPECTACLES

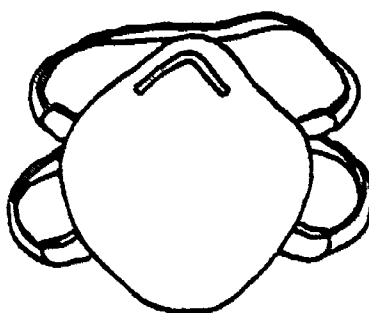

DUST MASK



RESPIRATOR

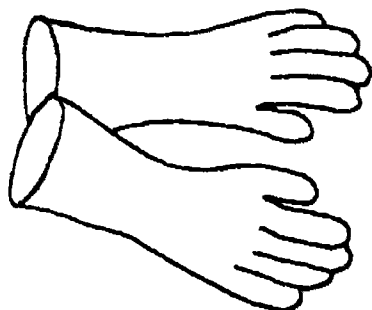

GLOVES

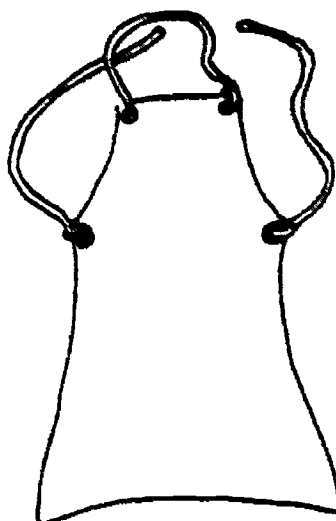

PROTECTIVE APRON

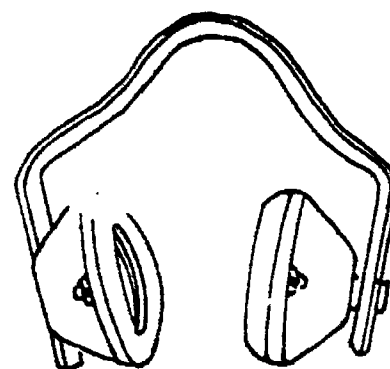

**HEARING PROTECTOR
EAR MUFFS**

Eye wash stations should be a part of any classroom in which visual arts materials are used. Many types of eye wash stations are available from safety suppliers, including the foot operated type, and emergency showers which serve additional purposes. Emergency showers should be present whenever concentrated acids or alkalis are used.

Though inexpensive, bottle type eye wash units are not recommended because the unit can easily become contaminated by bacteria, which can cause additional problems. A new type of unit can be attached directly to the sink faucet by threading it into the fixture. A push of a button allows for the water flow to go into the eye wash unit; returning this stopper to the original position allows for normal operation of the faucet. With a pre-established water temperature and properly maintained flow rate, this faucet unit is a practical, safe, and relatively inexpensive solution.

EYE WASH FOUNTAINS AND SAFETY SHOWER

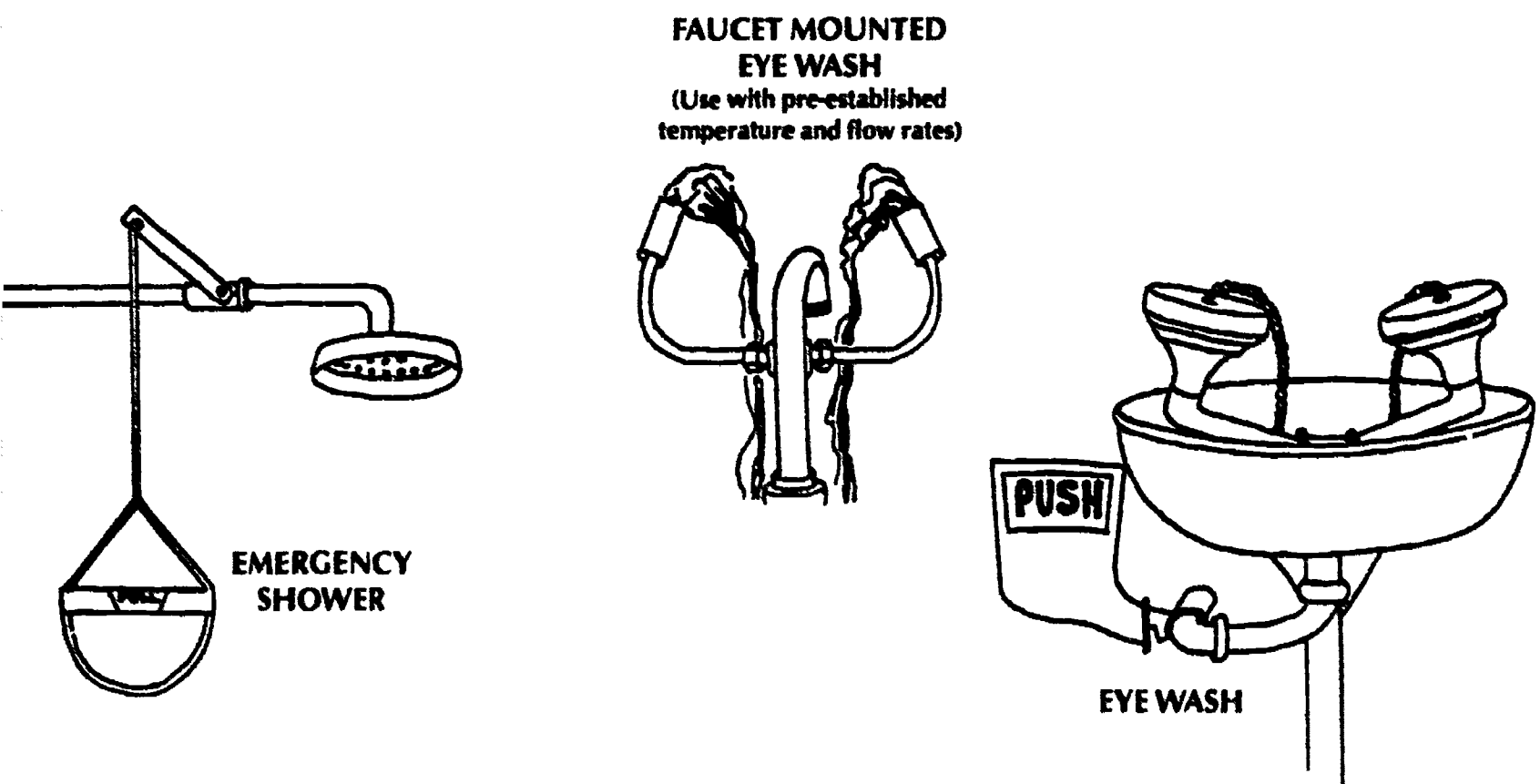

Common sense tells the educator that safe noise levels are important in order to give instructions, especially in an emergency situation. However, safe noise levels may require the use of properly fitted ear plugs, ear muff type protectors, or a combination of both. Noise exposure must

be reduced to a safe level. In the educational setting, this is often impractical (because of individual equipment needs) unless an activity can be isolated. McCann (1979, p. 105) states:

If you have to talk loud or shout to communicate within three feet, if you hear head noises or ringing in the ears (tinnitus) after being in a noisy area, if you experience a hearing loss after several hours exposure, or if you cannot hear yourself talk on the telephone - you probably have a noise problem.

Finally, good personal hygiene can reduce the exposure of students and the teacher to toxins. Eating, drinking, and smoking are inappropriate to the art classroom; ingestion of toxins can occur through such practices.

Breathing Easier: Ventilation

Ventilation is an important factor in reducing visual arts hazards, especially in secondary schools. Good general dilution ventilation should be provided in rooms where art materials are being used. An art classroom using space taken from an original area, which was designed as a storage room, probably has inadequate ventilation. General ventilation does not directly remove hazardous materials from the building; such systems with a low level air exchange actually pull fumes and particles around the building (to the cafeteria for example).

Some art teachers have traditionally told their students to wear their coats and the instructors then open the windows to provide ventilation. It should be recognized that such methods do not eliminate the problem, and in some cases may increase risk if the air flow is directed by a student's face. It would be better to temporarily eliminate the use of a material until a permanent solution can be achieved.

Local ventilation such as a canopy hood, vent, or fan is often required to remove contaminants. These systems allow toxins to be pulled away from individuals and to be exhausted outside. Some prefabricated local ventilation systems are available. For example, prefabricated spray booths are available from a number of manufacturers for a reasonable cost. But such units must be carefully evaluated to determine if they adequately serve one's safety needs.

For both general dilution and local exhaust ventilation systems, replacement air must always be provided for the system to work properly. Exterior venting must be designed to prevent the re-entrance of the exhausted air.

Note that explosion-proof fans are necessary for ventilation processes involving various solvents. Local codes or NFPA standards should be consulted.

Industrial designers can provide valuable experience and expertise for resolving ventilation problems. They plan systems which meet the needs of the facility and the activity. However, most of these individuals draw their experience from designing ventilation systems for the workplace where noise levels can go rather high. The classroom is a different type of environment. Whenever possible, ventilation systems with fans or motors should be outside the classroom so that the instructor can give directions, etc. while the system is "on". For technical information on ventilation, see *Ventilation: A Practical Guide* by Nancy Clark, Thomas Cutter, and Jean-Ann McGrane.

Several types of ventilation units are illustrated on the next page.

LOCAL EXHAUST VENTILATION HOODS

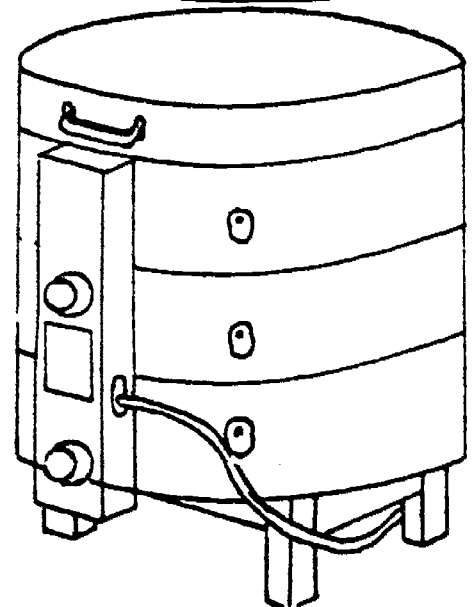
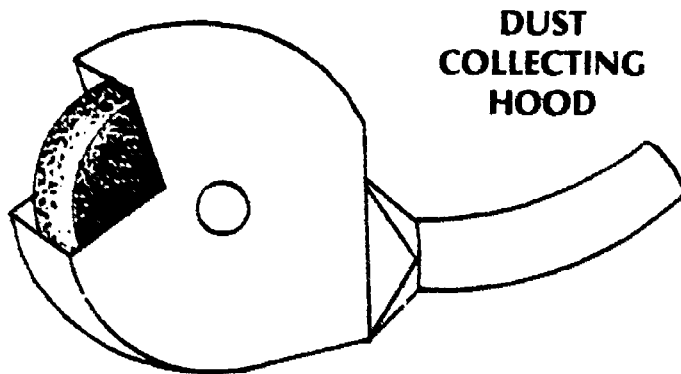
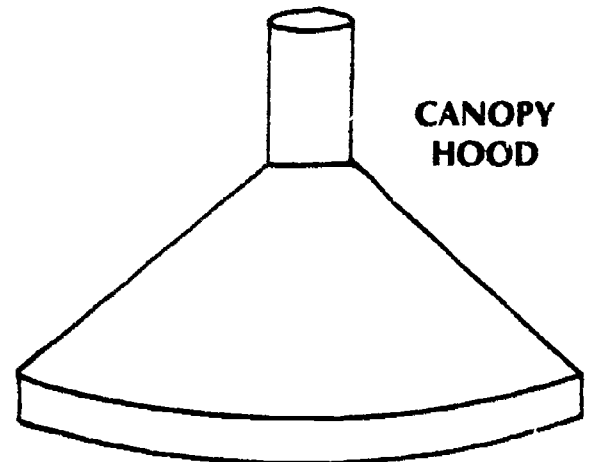
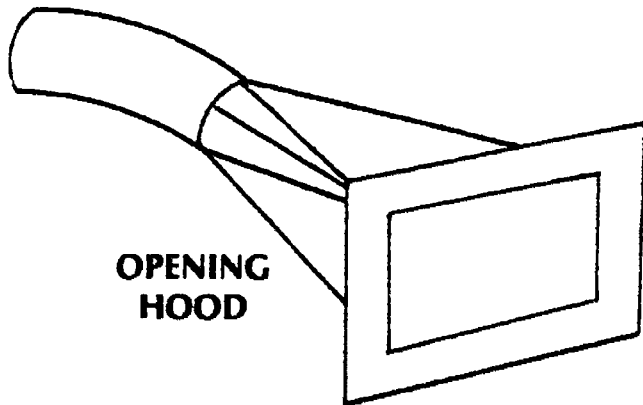
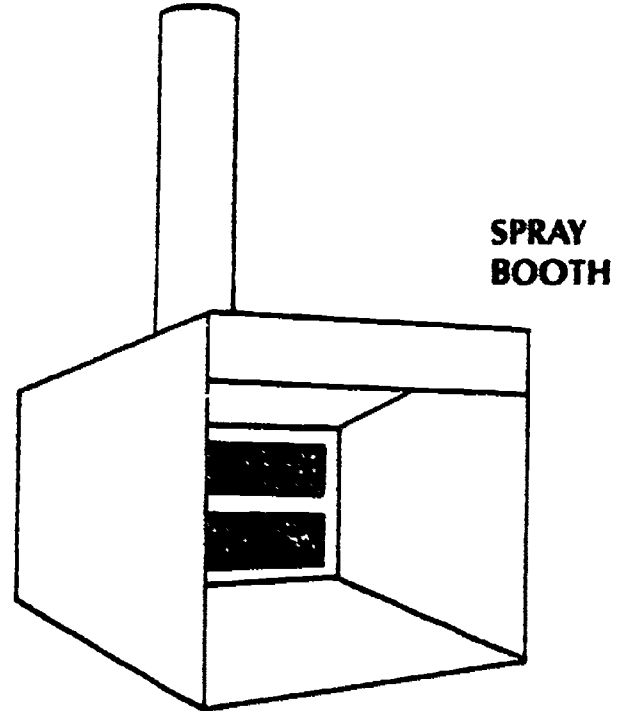
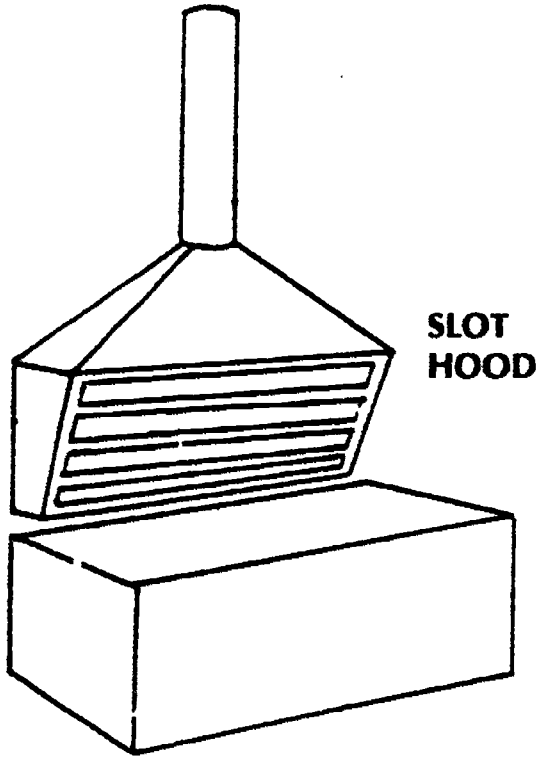

THE SAFE USE OF ART MATERIALS in the CLASSROOM

This portion of the publication is devoted to recommendations for the safe use of materials and equipment by the teacher and the students in high school, junior high, and elementary classrooms. Educators teaching in middle schools should use recommendations corresponding to the appropriate age group (either elementary or junior high).

Specific recommendations are organized under 10 sections for adhesives, ceramics, drawing and painting, enameling, glass, metals, photography, printmaking, sculpture, and textile arts. With each of the ten sections are three parts.

- 1) The first part, "**HAZARDS AND PRECAUTIONS**", identifies major problem areas for visual arts experiences. A comprehensive list of hazards and precautions can be found in *Artist Beware* (McCann, 1979).
- 2) The second part, "**MATERIAL USAGE**" lists the "**LEVELS OF MATERIAL USE**" (Teacher, Senior High, Junior High, Elementary) for art materials and equipment, as well as materials not to be used in a classroom setting. These recommendations are based upon the level of toxicity of the materials and the ability of the individual to understand and carry out safety instructions.

When the column entitled "**MATERIAL NOT TO BE USED**" is marked, the educator should recognize that these materials should **never** appear in the classroom; the risk to human health and safety is too great in these cases.

- 3) The third part, the "**SAFETY CHECKLIST**," itemizes safety equipment, storage practices, signs, etc. which correlate with the items in the "**MATERIAL USAGE**" section. This checklist section is basically a worksheet for the teacher. The checklist is to be used in documenting and planning individual classroom safety.

Within this third section, the educator can first check if the item is "**NOT IN USE**" or "**IN USE**" in his or her classroom. Moving to the right one finds a column of "**CORRESPONDING SAFETY EQUIPMENT AND PRACTICES**" which coincides with the material listing; all items on this safety equipment list are to be in place if a material is used in the classroom.

This list of safety equipment is primarily provided in the form of simple icons. An index to the meaning of these icons is provided on the following page and for convenient reference, is also repeated at the end of the publication.

Note that **black bars** corresponding to the subsection headings (such as Solvents, p. 40) list the safety equipment necessary for all materials that follow within the specific subsection of the listing.

At the extreme right of the Safety Checklist section one finds a set of columns marked **"IN PLACE"** and **"NEEDED"**. Here the educator can keep a record of safety equipment that actually is found in his or her classroom.

All equipment listed on the **"SAFETY CHECKLIST"** is to be used by both the teacher and students working with a process. Leave the ego outside the classroom; no one is unaffected by the hazards of art materials. Teachers should set an appropriate example of safe practices when using art materials and equipment in their classrooms.

The recommendations that follow are given with the understanding that all equipment and facilities are in proper working order. For example, no power equipment is to be operated if a guard is not in place, a structural support is cracked, or if a short occurs in the electrical wiring of the equipment.

Activities with these art materials are to be done under the supervision of the instructor, after safety instructions have been given to students. Only instructors with a comprehensive understanding of material and equipment safety for a specific process, should work with that process in the classroom.



SAFETY EQUIPMENT ICONS

Throughout the chart sections on pages 24-111, there are recommendations for safety equipment to be used with specific materials. Icons are used to provide this information in an easily recognizable manner. The icons used in this publication are identified below:

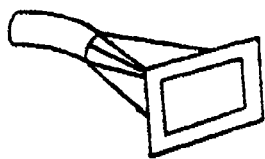

VENTILATION

GV - good general ventilation

L - local exhaust ventilation

C - canopy hood unit

P - portable exhaust unit

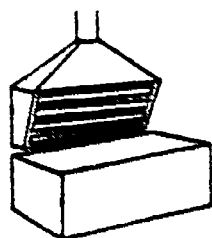

SLOT HOOD

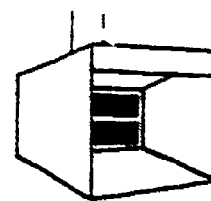

SPRAY BOOTH

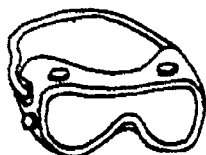

HOODED VENTILATED GOGGLES



SAFETY GLASSES



FACESHIELD



WELDING GOGGLES

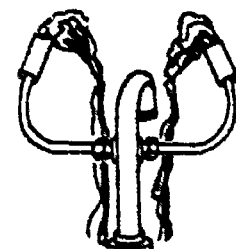

EYE WASH STATION

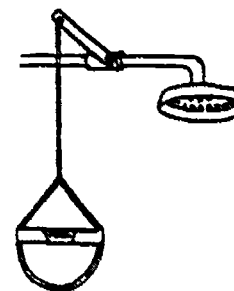

EMERGENCY SHOWER

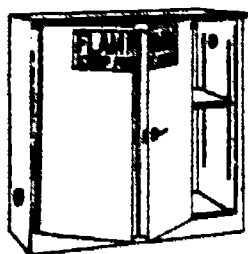

APPROVED FLAMMABLE STORAGE CABINET



SAFETY STORAGE CONTAINERS

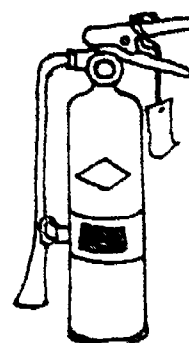

FIRE EXTINGUISHER



RESPIRATOR

O - organic vapor

A - acid gas

D - dust

(all NIOSH approved)



DUST MASK (2 straps)

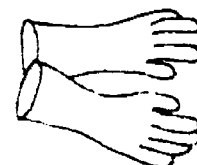

GLOVES

N - neoprene

TH - thermal

LE - leather

C - cotton

L - latex



NO OPEN FLAMES

Adhesives: Hazards and Precautions

Major hazards with glues and adhesives concern the flammability of these materials, and toxins which can enter the body, primarily through inhalation or ingestion. Because many of these materials are also found in the home and are regarded as every day materials, adequate precautions are often not exercised.

Water based glues and adhesives are the most appropriate for use in the classroom. Good water based choices for the teacher include: white glue or polymer adhesives, library paste, mucilage, polyvinyl acetate emulsions, school paste, and paste compositions made from flour. The teacher must be particularly careful in using wheat pastes. Choose a wheat paste variety with non-toxic labeling; commercial wallpaper paste often contains highly toxic substances. Many glue sticks can also be found in non-toxic based compositions. Animal glues such as dextrin or other water based glues often contain hazardous preservatives, and should only be used with older students. Dry casein powder is dangerous to the body by skin contact, inhalation, and ingestion; it is not a wise choice for the classroom.



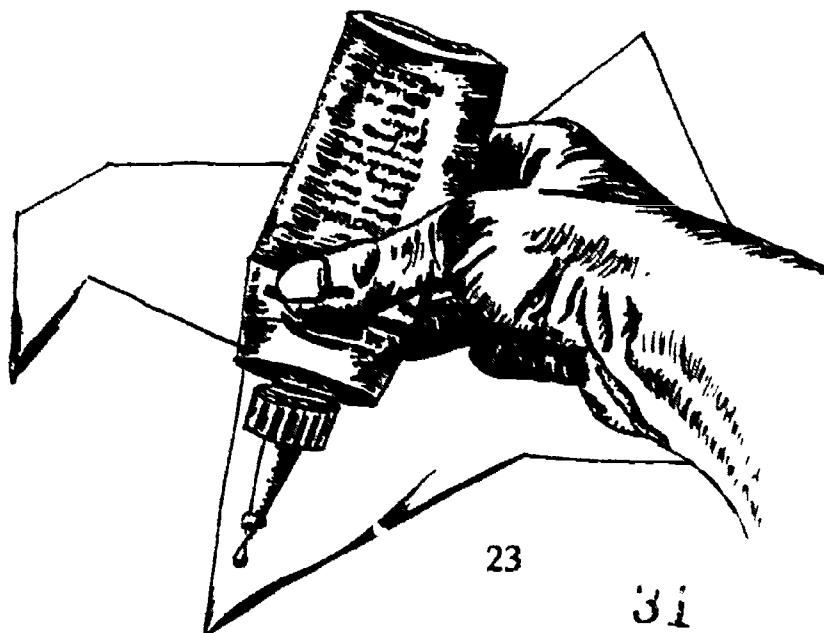

Flammable solvent based glues, including rubber cements or airplane (model) glue are hazardous primarily because of the inhalation and ingestion of the solvents. Use such solvent based glues only with older students; appropriate precautions include the use of extremely good ventilation, and standard flammables precautions. Rubber cement usually relies upon the evaporation of hexane in order to dry; a rubber cement containing heptane would be preferred as it is less toxic. Vapors can be greatly reduced by keeping containers covered between applications. Non-flammable varieties of rubber cement are available, but of questionable composition; they must also be used with the utmost caution and extremely good ventilation. A reasonable alternative to rubber cement for paste-up in graphics or advertising classes may be a hot wax applicator. One or two of these tools can be used for a class if only periodically needed by students. Airplane (model) glues containing toluene (highly toxic by inhalation) should only be used in small amounts with local ventilation in an area away from open flames.

Particular precautions must be taken in the use of cyanocrylate (instant) glues. In addition to good local ventilation, care must be exercised to avoid eye contact or permanently gluing the skin together. Teachers should be sure that first aid instruction is part of student safety training with all instant glues.

Glues which rely on the combination of chemicals such as epoxy glue and polyurethane adhesives also contain highly toxic solvents and chemicals. The use of polyurethane adhesives is not recommended in the schools. Epoxy glues should be reserved for use in the high school setting; avoid skin contact when working with epoxy glues and use them with good dilution ventilation.























ADHESIVES MATERIAL USAGE

MATERIALS	MATERIAL NOT TO BE USED	LEVELS OF MATERIAL USE			
		TEACHER	SENIOR HIGH	JUNIOR HIGH	ELEMENTARY
Airplane glue (toluene) - solvent based		X	X	X	
Animal glues		X	X	X	
Casein glues	X				
Cyanocrylate instant glues		X	X		
Dextrin glues		X	X	X	
Epoxy Adhesives		X	X		
Glue Sticks		X	X	X	X
Homemade glue: flour and water		X	X	X	X
Library paste		X	X	X	X
Mucilage		X	X	X	X
Polyvinyl acetate emulsions		X	X	X	X
Polymer adhesives		X	X	X	X
Polyurethane adhesives	X				
School paste		X	X	X	X
Rubber cement: standard (hexane)	X				
Rubber cement: non-flammable		X	X		
Water based contact cement		X	X		
Wheat paste: non-toxic		X	X	X	X
Wheat paste: wallpaper paste	X				
White glue		X	X	X	X



Indicates that the material is available in a product form considered to be safe for children by the California State Department of Health Services.

ADHESIVES SAFETY CHECKLIST

ART MATERIALS OR EQUIPMENT		APPROPRIATE SAFETY EQUIPMENT		
NOT IN USE	IN USE	CORRESPONDING SAFETY EQUIPMENT AND PRACTICES	IN PLACE	NEEDED
		 L 		
		 GV		
		 L   		
		 GV		
		 GV 		
		 GV		
		 GV		
		 GV		
		 GV		
		 GV		
		 GV		
		 GV		
		 L		
		 GV		
		 GV		
		 GV		

Ceramics: Hazards and Precautions

Ceramics units are part of many curriculums at all age levels. The plasticity of this three-dimensional material is particularly inviting. The educator's major safety concerns are various types of dust and good hygiene. Absolutely no eating, drinking, or smoking is to be allowed near ceramic materials as the ingestion of toxic particulates, when using such materials, is unavoidable.

Dry clay substances can cause respiratory problems (such as silicosis) with extended exposure over a period of years. The high silica levels in clay, glaze powders, grog, etc. are all very hazardous. The educator should control dusts by using wet clay materials. The use of pug mills or clay mixers creates large amounts of dust and therefore such units should not appear in schools. Do not mix dry clay substances.



Only use **wet clay** bodies in the classroom setting. But dried wet clay on any surface again becomes dry clay, which again can result in hazardous situations. A wet mop is the appropriate tool for cleanup. Sweeping creates more airborne dust. Another option, though expensive, is a HEPA filter vacuum which can adequately control very fine dust. Normal shop-vacs create more inhalation problems from airborne dust particles.

Glaze mixing is a process for the teacher. Many glaze ingredients can be hazardous in dry or wet form, or when they vaporize while being fired in the kiln. Glaze mixing should be done with protective clothing, gloves, and a NIOSH approved respirator. Lead and lead frits should not be used in any K-12 classroom because of the possibility of lead poisoning. Even lead frits, fired properly, can pass lead on to other vessels in the firing process. Lead glaze used on any vessel intended for food or drink can result in lead poisoning. Use only lead-free liquid glazes with secondary students.

The use of approved glazes for young elementary students is not recommended. For decorating the surface of ceramic forms, teachers of such youngsters should substitute color materials such as acrylics. Very pleasing results can be obtained from a variety of color materials that are safe for the elementary school student. Teachers are reminded that glazes must be properly fired to be considered safe. When glazes are improperly fired, it is possible for harmful chemicals to leach out. Therefore, the production of vessels to be used for eating or drinking (possible ingestion hazards) are not encouraged in the school setting.

Ceramic colorants including chrome yellow, uranium oxide, zinc yellow, nickel, cadmium, lead, and antimony are highly toxic by inhalation (some are suspected of causing cancer). Do not use these toxic materials in the classroom.

Glaze application by secondary students, which is done by brushing, dipping, or slip trailing is relatively safe if the glazes contain no major toxins (such as lead). However, the spraying of glaze creates fine particles of the material, and should be done in a spray booth. A respirator for one person, in place of a spray booth, is not a wise choice in a room filled with students. Cleanup of glaze materials should also be done as a wet process. Do not sweep or brush up dry glaze materials.

Wax heated for wax resist techniques should always be heated in a double boiler on a temperature controlled hot plate. Wax can explode if heated at a high temperature.

Kilns, whether gas, electric, or raku, give off large amounts of heat and are more appropriately placed outside of the classroom. Raku kilns are usually fired out of doors. Any kiln fired inside a building should be vented outside with a canopy hood to remove dangerous fumes such as sulfur dioxide, carbon monoxide, and metal fumes. The CFM of air flow is an important factor in removing all fumes. Though low-sulfur clay bodies are available, ventilation is still required. Opening windows does not solve the kiln ventilation problem.

Flammables should never be stored or used anywhere near the kiln. Local firing regulations should be checked regarding kiln location and firing. As important safeguards, overfiring kilns need two automatic shutoffs: 1) a pyrometer or cone shutoff and 2) a timer. In addition, the kiln should be manually checked to be sure it has shut off.

The **equipment** most common to the art room ceramics program is the potter's wheel. It often appears in secondary art classrooms and occasionally in elementary classes. Mechanical hazards are possible from children getting caught in moving parts or a short caused by the combination of water and the electric motor or cords of an electric potter's wheel. Check the electric systems of electric wheels often. Specialized ceramics equipment often appears in secondary programs. Extruders, slab rollers, and other such equipment should only be used by well-trained students under the careful supervision of the instructor.











CERAMICS MATERIAL USAGE

MATERIALS	MATERIAL NOT TO BE USED	LEVELS OF MATERIAL USE			
		TEACHER	SENIOR HIGH	JUNIOR HIGH	ELEMENTARY
Asbestos, asbestos contaminated talcs	X				
Ceramic colorants: chrome yellow, uranium oxide, zinc yellow	X				
Ceramic colorants: nickle	X				
Ceramic colorants: cadmium, lead, antimony	X				
Ceramic colorants, powdered: cobalt carbonate, cobalt oxide, copper carbonate, copper oxide (red/black), iron oxide (red/black), iron sulfate, rutile, tin oxide, vanadium, zinc oxide		X			
Clay dry, powdered (small amounts only)		X			
Clay: slip		X	X	X	X
Clay: wet		X	X	X	X
Extruder		X	X		
Glazes: engobes, colored slips		X	X	X	
Glazes: lead	X				
Glazes: lead-free liquid		X	X	X	X
Glazes: lusters		X	X		
Glazes: salt (hydrogen chloride gas)	X				
Glazes: sprayed		X	X		
Glazes: underglaze		X	X	X	
Grog - powdered ground firebrick (small amounts only)		X			



Indicates that the material is available in a product form considered to be safe for children by the California State Department of Health Services.



CERAMICS SAFETY CHECKLIST

ART MATERIALS OR EQUIPMENT		APPROPRIATE SAFETY EQUIPMENT		
NOT IN USE	IN USE	CORRESPONDING SAFETY EQUIPMENT AND PRACTICES	IN PLACE	NEEDED
		 OR   wet mop		
		 OR  wet mop		
		preservatives to prevent mold	wet mop or approved vacuum	
		wet mop or approved vacuum		
		plunger lock functioning		
		wet mop or approved vacuum		
		wet mop or approved vacuum		
		wet mop or approved vacuum		
		 wet mop or approved vacuum		
		wet mop or approved vacuum		
		 OR  wet mop		

CERAMICS MATERIAL USAGE

MATERIALS	MATERIAL NOT TO BE USED	LEVELS OF MATERIAL USE			
		TEACHER	SENIOR HIGH	JUNIOR HIGH	ELEMENTARY
Kilns: electric, gas		X			
Kilns: raku		X			
Potter's wheels		X	X	X	X
Pug mill	X				
Slab rollers		X	X	X	
Wax resist		X	X	X	

CERAMICS SAFETY CHECKLIST

ART MATERIALS OR EQUIPMENT		APPROPRIATE SAFETY EQUIPMENT				
NOT IN USE	IN USE	CORRESPONDING SAFETY EQUIPMENT AND PRACTICES		IN PLACE	NEEDED	
			infrared goggles shade #1.7 - 3.0	automatic shut off kilnsitter		
		sign "No Flammables"	sign "Danger: Kiln Being Fired"			
		isolated exterior firing place	infrared goggles shade #1.7 - 3.0			
		 tongs	protective clothing			
		good electric connections and cords				
		temperature controlled hot plate	double boiler			

Drawing and Painting: Hazards and Precautions

Drawing materials involve relatively few problems in comparison to other art materials. Use drawing materials in the elementary schools that are approved by the California State Department of Health Services. Whenever possible these approved art materials should be the choice for secondary schools as well.

Dusts from charcoal or pastels are fine particles that can enter the respiratory system and should be controlled by wet cleanup processes. The **aerosol fixatives** used on these drawing materials are extremely dangerous because of the organic solvents they contain. If such sprays must be used, they should be used only by the teacher or older students, either out of doors or in a spray booth.

Oil pastels and crayons are available which are approved by the California State Department of Health Services ; use these approved materials as some materials labeled non-toxic may be hazardous. Permanent **markers** and solvent based inks emit vapors that should be controlled with 10 air exchanges per hour with 100% exhaust to the outside. Water based markers are the best choice of marker for any school setting. But young children should probably not be allowed to work with these water-based materials, as the dyes possibly can cause risks to children. The popular scented varieties (cherry, grape, etc.) pose particular concern for young children as they are prone to put such materials in their mouths; such a practice may develop the inappropriate habit of eating or smelling art materials.

Painting materials come in a large variety. Some forms of both the bases and pigments can cause damage to the human body. The grinding of one's own pigment powders should not occur in schools as the risks of inhalation are too great. A large variety of materials on the market can accommodate classroom needs. There are varieties of inorganic pigments such as lead, chromates, manganese, and cadmium that pose problems for the body, while most of the organic pigments' long term effects are unknown.

Water emulsion **acrylics, tempera** (cake, liquid, & powder), and **watercolors** (crayons, dry pan, semi-moist, & markers) are available which are found on the California State Department of Health Services list of children's approved art materials. These rated products should be used whenever possible. Solvent based polymer acrylics should not be used as they pose an unnecessary hazard by inhalation and ingestion.

Special paint processes are occasionally attempted in schools, particularly with older students. **Encaustic** processes using wax are of concern because of the decomposition of wax in the melting process. Use a double boiler and a temperature controlled hot plate for wax. **Fresco** painting involves the use of highly corrosive limewater and therefore the process should not be attempted in schools. **Epoxy paints**, often used for murals, cause a large number of skin and respiratory allergies. Do not use epoxy paints in school settings. **Casein** is sometimes used as a binder for tempera processes. Avoid using ammonium hydroxide (highly toxic by eye contact, inhalation, and ingestion), and do not use tetrachloroethane (which causes liver damage) to dissolve the casein, as soluble forms are available.

Oil painting is often regarded as a special creative experience for the student. The problem in using these materials arises primarily from the solvents and resins used to thin, dry, or clean up the paint. Qualley (1986, p.67) states "there is nothing significantly special to be learned about painting through the use of oils to justify either the trouble or expense to make them safe to work within the classroom." Advanced high school students can learn a lot about color and light by layering thin washes of oil paint on the canvas; however, this process creates a great amount of

vapor and should only be attempted in extremely well ventilated studios. Only two or three students should be permitted to paint with oils at one time, as large amounts of solvents are used by each individual student. Exhaust fans and covered brush cleaners and solvent containers are necessary to reduce vapors.

Normal precautions for solvents concerning flammability and clean up are appropriate. Use self closing safety disposal containers for all rags and paper towels at the end of each class period. Elementary students should not work with solvents as the extent of safety precautions is too much responsibility for young children.

For secondary students, use the least toxic solvent available for the process being used. For example: clean up of oil base paint on brushes should be done with mineral spirits; clean up of oil base paints from the hands should be done with baby oil followed by soap and water; and the use of turpentine substitute (fairly expensive) instead of turpentine reduces the amount of toxic vapors in the studio. But even with the use of the least toxic substance some students will have individual sensitivity. Limit the use of solvents as much as possible in all classroom settings.



DRAWING & PAINTING MATERIAL USAGE

MATERIALS	MATERIAL NOT TO BE USED	LEVELS OF MATERIAL USE				
		TEACHER	SENIOR HIGH	JUNIOR HIGH	ELEMENTARY	
DRAWING						
Chalk: white; dustless		X	X	X	X	
Chalk: colored; dustless		X	X	X	X	
Charcoal		X	X	X	X	
Crayons: molded or pressed		X	X	X	X	
Crayons: oil pastels		X	X	X	X	
Crayons: watercolor		X	X	X	X	
Fixative: aerosol spray		X	X			
Graphic masking liquids		X	X	X	X	
Inks: drawing; water based		X	X	X	X	
Inks: drawing; solvent based (small amounts)		X	X	X		
Inks: lettering; water based		X	X	X	X	
Inks: lettering; solvent based (small amounts)		X	X	X		
Markers: waterbase		X	X	X	X	
Markets: permanent		X	X			
Pastels: dustless		X	X	X	X	
Pastels: containing French chalk (talc)	X					
Pencils: colored		X	X	X	X	
Pencils: graphite; leads		X	X	X	X	



Indicates that the material is available in a product form considered to be safe for children by the California State Department of Health Services.

DRAWING & PAINTING SAFETY CHECKLIST

ART MATERIALS OR EQUIPMENT		APPROPRIATE SAFETY EQUIPMENT		
NOT IN USE	IN USE	CORRESPONDING SAFETY EQUIPMENT AND PRACTICES	IN PLACE	NEEDED
		wet mop		
		wet mop		
		wet mop		
		explosion proof organic vapor paint respirator with dust & mist filter (teacher only)		
		good ventilation: 10 air exchanges / hour		
		good ventilation: 10 air exchanges / hour		
		good ventilation: 10 air exchanges / hour		
		wet mop		



DRAWING & PAINTING MATERIAL USAGE

MATERIALS	MATERIAL NOT TO BE USED	LEVELS OF MATERIAL USE				
		TEACHER	SENIOR HIGH	JUNIOR HIGH	ELEMENTARY	
PAINTING						
Acrylic artists colors: water emulsion		X	X	X	X	
Acrylic artists colors: solvent based	X					
Acrylic media: gel, gloss, matte, modeling paste, retarder, extender		X	X	X	X	
Acrylics: artists washable		X	X	X	X	
Airbrush pigments & dyes: water based		X	X			
Airbrush pigments & dyes: solvent based	X					
Alkyd paints	X					
Brush care products		X	X	X	X	
Casein (premixed)		X	X			
Encaustic paints		X	X	X		
Epoxy paints	X					
Epoxy resins	X					
Fabric paints		X	X	X	X	
Finger paint: liquid		X	X	X	X	
Finger paint: powdered		X	X	X	X	
Fresco materials (lime, lime water)	X					
Gesso		X	X	X	X	
Masking liquids		X	X	X	X	



Indicates that the material is available in a product form considered to be safe for children by the California State Department of Health Services.

DRAWING & PAINTING SAFETY CHECKLIST

ART MATERIALS OR EQUIPMENT		APPROPRIATE SAFETY EQUIPMENT		
NOT IN USE	IN USE	CORRESPONDING SAFETY EQUIPMENT AND PRACTICES	IN PLACE	NEEDED
				
				
		double boiler	temperature controlled hotplate	
		wet mop		



DRAWING & PAINTING MATERIAL USAGE

MATERIALS	MATERIAL NOT TO BE USED	LEVELS OF MATERIAL USE			
		TEACHER	SENIOR HIGH	JUNIOR HIGH	ELEMENTARY
Oil colors (small amounts)		X	X		
Oil paints: hand ground pigment powders	X				
Oil paints: toxic inorganic pigments	X				
Pigment powders	X				
Spray paints		X	X		
Tempera: cake		X	X	X	X
Tempera: liquid		X	X	X	X
Tempera: powdered		X	X	X	X
Vinyl paints		X	X	X	X
Watercolor: crayons		X	X	X	X
Watercolor: dry pan		X	X	X	X
Watercolor: gouache (designer colors)		X	X	X	
Watercolor: semi-moist		X	X	X	X
Watercolor: markers		X	X	X	X
Watercolor: tube		X	X	X	X
SOLVENTS					
Alcohol: denatured		X	X	X	
Alcohol: ethyl		X	X	X	X
Alcohol: methyl	X				
Ammonium hydroxide	X				



Indicates that the material is available in a product form considered to be safe for children by the California State Department of Health Services.

DRAWING & PAINTING SAFETY CHECKLIST

ART MATERIALS OR EQUIPMENT		APPROPRIATE SAFETY EQUIPMENT				
NOT IN USE	IN USE	CORRESPONDING SAFETY EQUIPMENT AND PRACTICES		IN PLACE	NEEDED	
		exhaust fans	baby oil	contained brush cleaners	self-closing disposal can	
		explosion proof				
		 (teacher only)				
						

DRAWING & PAINTING MATERIAL USAGE

MATERIALS	MATERIAL NOT TO BE USED	LEVELS OF MATERIAL USE			
		TEACHER	SENIOR HIGH	JUNIOR HIGH	ELEMENTARY
Benzine (VM & P naphtha)		X	X		
Lacquer thinner	X				
Linseed oil		X	X	X	
Mineral spirits (paint thinner)		X	X	X	
Paint / varnish removers: methylene chloride	X				
Paint / varnish removers: toluene, xylene	X				
Pure driers	X				
Tetrachloroethane	X				
Turpentine	X				
Turpentine substitute		X	X		
Varnishes		X	X		

Enameling: Hazards and Precautions

Enameling has been removed from many elementary and junior high programs due to its cost. More accurately, it should have been removed because of the hazards of the process. The dusting of toxic chemicals by children is an exercise of poor judgement. Enameling should be limited to secondary schools with more complex processes being done only at the high school level.

Metal cleaning involves heating the metal, cooling the metal with water, and subsequently removing the fire scale with acid or Sparex. Normal precautions for heating metal with the kiln or torch should be exercised. As nitric acid can release toxic gas during the cleaning operation, Sparex is the preferred pickling agent. Gloves should be worn for work with Sparex or acids, and in addition, goggles and a plastic apron should be worn with acids. Use these acids with proper ventilation with a fume hood. Whenever acids are used, an eyewash station and emergency shower should be readily at hand.

The **preparing of enamels** in schools is not worth the effort. The risks are similar to those of mixing glazes. A more appropriate choice for the classroom is prepared lead-free enamels such as Vitrac.

Application of enamels can be done with the dusting, painting, dipping, or spraying of these materials. When applying enamels by dusting, execute this process inside of a fume hood or spray booth. In addition, a spray booth is needed for enamel spraying processes. Dipping and painting are the preferred processes of applying enamels for the classroom. All solvents in the enameling process should be handled with gloves. Normal precautions for the handling and disposal of flammable solvents must be exercised. Keep these solvents away from the kiln area. Good hygiene in the clean up process is essential. Wet mop for the clean up of enamel materials, do not sweep.

The **enameling kiln** used to melt the enamels must be operated with leather gloves, tongs, infrared goggles, and is always to be operated with proper ventilation (canopy hood or window exhaust fan) in order to remove toxic fumes from the classroom. No flammables should be stored or used anywhere near the kiln. Kiln use should be carefully monitored by the teacher.

Equipment used in advanced techniques with enamels includes torches for heating the metal, and grinders and buffers for finishing the metal. A torch used for soldering should be used with protective clothing, a fire extinguisher readily available, and with very good ventilation. Do not use fluoride fluxes or cadmium containing solders because the fumes are extremely toxic by inhalation. Grinders and buffers must be operated with local exhaust ventilation, an equipment guard in place, and goggles on the student or teacher.

Acid baths used in the champleve method for removal of metal recesses should be used in a fume hood. Acid baths are to be covered when not in use. Use gloves and goggles when working with the acid and neutralize the bath with sodium bicarbonate before discarding in the sink. To aid in saving your plumbing, flush the sink with cold water for 5 minutes after disposal.

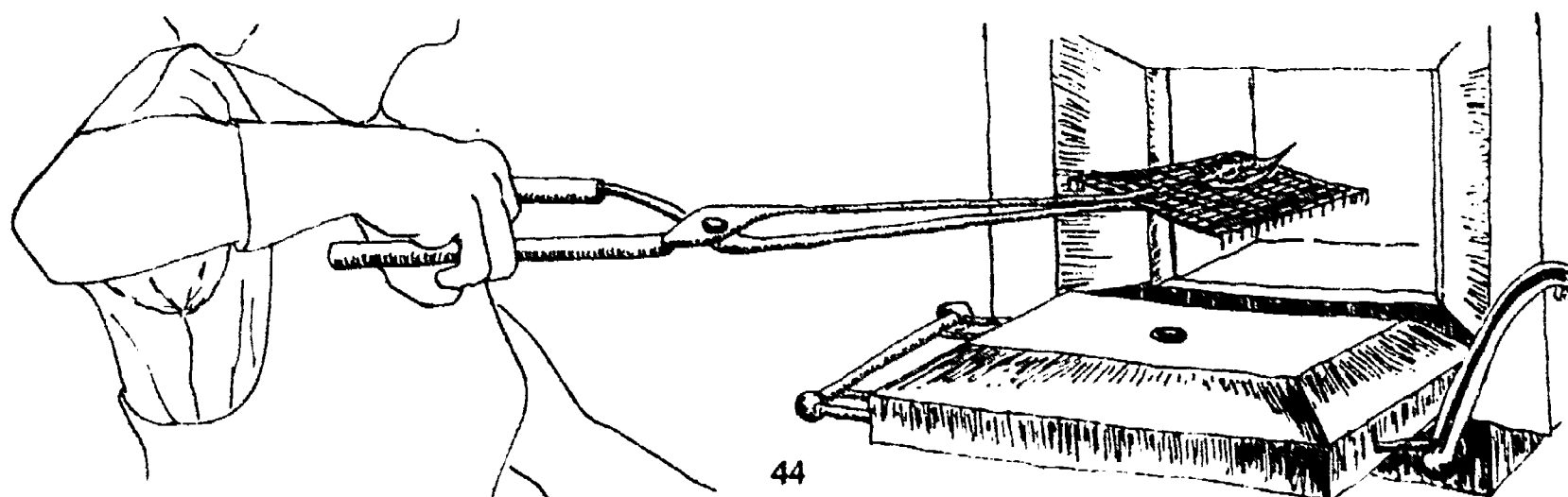











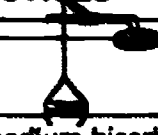





44

ENAMELING MATERIAL USAGE

MATERIALS	MATERIAL NOT TO BE USED	LEVELS OF MATERIAL USE			
		TEACHER	SENIOR HIGH	JUNIOR HIGH	ELEMENTARY
Acids: nitric; sulfuric		X	X		
Acid baths		X	X		
Buffer		X	X	X	
Enamels: dry, lead free		X			
Enamels: lead	X				
Enamels: liquid, lead free		X	X	X	
Flux		X	X		
Flux: zinc chloride, fluoride	X				
Grinder		X	X	X	
Gum tragacanth		X	X	X	
Etching materials: fluoride pastes		X	X		
Etching materials: hydrofluoric acid	X				
Kilns: enameling		X	X	X	
Lacquer thinners	X				
Nitrobenzene	X				
Potash (potassium carbonate)		X	X		
Self prepared enamels	X				
Silver solder: cadmium containing	X				

ENAMELING SAFETY CHECKLIST

ART MATERIALS OR EQUIPMENT		APPROPRIATE SAFETY EQUIPMENT						
NOT IN USE	IN USE	CORRESPONDING SAFETY EQUIPMENT AND PRACTICES		IN PLACE	NEEDED			
						plastic apron		
		acid bath cover	fume hood	sodium bicarbonate (neutralizer)				
		tongs	sign "Caution Acid Area"	sign "Gloves and Goggles MUST be Worn"				
				safety guard				
								
								
								
				safety guard				
								
			or window exhaust fan		infrared goggles shade #1.7 - 3.0			
		sign "Danger No Flammables"	tongs	sign "Caution: Kiln Being Fired"				
								

Glass: Hazards and Precautions

Working with glass is an activity that should be reserved until students reach secondary schools. Stained glass processes can be handled by junior high students while glassblowing (free-blown and lampwork) should only be attempted by the most advanced high school students.

For **stained glass**, the cutting process must be controlled to avoid damaging the skin. When using a cutter or grazing pliers, goggles must be worn. Reduce the chance of cuts by smoothing pieces of glass on a grinding wheel or with abrasive paper. Grinding operations also require the use of goggles and wet processes should be used to help avoid dust problems. Gloves are appropriate safety measures for handling sharp glass pieces throughout cutting and assembly processes. Clean up operations should involve wet mop processes on all work surfaces and the floor.

The handling of lead came must include careful hygiene and clean up procedures. Lead dust from cutting must never be allowed to come in contact with the mouth; this can create a significant ingestion hazard. Care must also be used in handling the sharp edges of the lead came.

Soldering processes should also be done with care. Acid core solders should not be used; instead, use a lead and tin mixture of 60 - 40 or 50 - 50. Local exhaust ventilation or a slot hood is the preferred method to expel hazardous airborne materials; however, an open window and an appropriate exhaust fan blowing the fumes out of the window is a reasonable alternative. Canopy hoods should not be used for soldering operations as the fumes will be forced past the user's face, creating an inhalation hazard.

For **glassblowing and lampworking processes**, the use of cullet or second melts is the best choice in contrast to the use of batch processes. The hazards of working with chemical powders are not justified in schools.

Heating processes of furnace and annealing ovens create large amounts of heat which can cause heat stroke, heat syncope, heat fatigue, heat rash, or thermal burns. Infrared radiation produced from the hot glass can damage the skin and cause cataract problems. Appropriate infrared barriers, goggles, and clothing must be used to protect the glassblower. Due to toxic fumes, all furnaces should be ventilated with local exhaust ventilation. Proper wiring for electrical furnace systems and control of the gas lines of gas-firing furnaces are essential to safe studio practice. Torch work done in lampworking not only involves problems of heat and fumes, but additional fire hazards related to the use of either oxyacetylene or propane torches.







The decorating of glass poses hazards through inhalation and skin contact. Do not use spraying techniques (extremely high inhalation hazard), but rather, dipping and painting processes. Marvering, fuming, and firing must be completed with local exhaust ventilation because of potential hazards of metal fume fever and other poisoning hazards.

Machine techniques for cutting and finishing glass pose a variety of problems. Goggles are to be worn to protect the eyes from glass pieces with all cutting and finishing machines. Sand, which can cause silicosis, should not be used for sandblasting; use less hazardous abrasives such as silicon carbide, alumina, glass beads, or crushed walnut shells. Hydrofluoric acid, often used in finishing glass, is highly corrosive and highly toxic by inhalation and therefore should not be used. Use fluoride pastes with gloves and goggles for such finishing work.

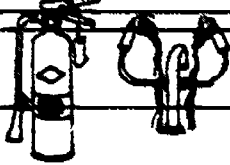
GLASS MATERIAL USAGE

MATERIALS	MATERIAL NOT TO BE USED	LEVELS OF MATERIAL USE			
		TEACHER	SENIOR HIGH	JUNIOR HIGH	ELEMENTARY
STAINED GLASS					
Antimony sulfide (antiquing)	X				
Copper foil (glazing)		X	X		
Copper sulfate (antiquing)		X	X		
Epoxy resins	X				
Flux: oleic acid		X	X		
Flux: zinc chloride	X				
Glass cutter: diamond, steel wheel		X	X		
Glass colorants and enamels (See pp. 44 - 49)					
Hydrofluoric acid (etching)	X				
Kiln: gas, electric		X	X		
Lead came		X	X		
Red lead: powdered (drying agent)	X				
Selenium dioxide (antiquing)	X				
Solder: tin / lead, acid core	X				
Solder: tin / lead		X	X		
Silver nitrate	X				
Wiring		X	X	X	







GLASS SAFETY CHECKLIST

ART MATERIALS OR EQUIPMENT		APPROPRIATE SAFETY EQUIPMENT		
NOT IN USE	IN USE	CORRESPONDING SAFETY EQUIPMENT AND PRACTICES	IN PLACE	NEEDED
				
				
				
		 grinder (or abrasive paper) for sharp edges		
		 or window exhaust fan	infrared goggles shade # 1.7 - 3.0	
		sign "Danger: No Flammables"	tongs	sign "Caution: Kiln Being Fired"
		wet mop		
				
				

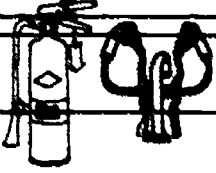
GLASS MATERIAL USAGE

MATERIALS	MATERIAL NOT TO BE USED	LEVELS OF MATERIAL USE			
		TEACHER	SENIOR HIGH	JUNIOR HIGH	ELEMENTARY
GLASS BLOWING					
Ammonium bifluoride / fluoride (finishing)	X				
Annealing ovens		X	X		
Chemical powders: miscellaneous	X				
Chemical powders: arsenic oxide, lead	X				
Colorants / reducing agents: arsenic oxide, cadmium sulfide, nickel, sodium cyanide, uranium oxide	X				
Colorants / reducing agents: miscellaneous		X			
Cullet (second melts) Borosilicates (Pyrex)		X	X		
Cullet (second melts): lead / potash glasses		X	X		
Cullet (second melts) opal or opaque glasses		X	X		
Cullet (second melts) soda / lime glasses		X	X		
Cullet (second melts) arsenic formulations	X				
Cutting & finishing equipment diamond glass saws, edge bevells, glass lathes, grinders, polishers		X	X		
Decorating materials: dipping, painting		X	X		
Decorating materials: marvering		X	X		
Decorating materials: spraying	X				

GLASS SAFETY CHECKLIST

ART MATERIALS OR EQUIPMENT		APPROPRIATE SAFETY EQUIPMENT		
NOT IN USE	IN USE	CORRESPONDING SAFETY EQUIPMENT AND PRACTICES	IN PLACE	NEEDED
				
		see "Furnaces" on next two pages		
		 fume hood wet mop		
		special clothing		
		see precautions for process		
		↓		
		 protective clothing wet machine processes		
				
		  OR fume hood		
				

**GLASS
MATERIAL USAGE**

MATERIALS	MATERIAL NOT TO BE USED	LEVELS OF MATERIAL USE			
		TEACHER	SENIOR HIGH	JUNIOR HIGH	ELEMENTARY
Furnaces: electric, fuel fired		X	X		
Hydrofluoric acid (finishing)	X				
Lampworking: propane or oxyacetylene torch		X	X		
Sandblasting: alumina, silicon carbide, glass beads, walnut shells		X	X		
Sandblasting: sand	X				
Sulfuric acid (finishing)		X	X		

Metals: Hazards and Precautions

The use of metals for the making of sculpture or jewelry involves many hazards which should be carefully evaluated by the educator. Most of these processes should be reserved for the high school years. While a number of metals techniques may be appropriate for junior high school students, the risks involved in metal processes negate their use in the elementary schools.

Casting hazards involve problems in the creation of molds and heat problems occurring during the actual heating processes. Inhalation problems of asbestos and silica investment plasters involve unnecessary risks that can be reduced by using powdered pumice, plaster, or other non-silica investments. Similarly, due to the inhalation of powders, foundry sands should be used instead of silica sands and resin binders. Wet mopping is appropriate for cleanup of these materials as this will reduce dust.

Melting of metals involves large amounts of heat and toxic fumes. Local exhaust ventilation is necessary for all metal melting and pouring operations. Protection from the heat includes infrared goggles, protective clothing, and a face shield.

The **metal heating** processes of soldering, welding, and brazing involve numerous hazards related to high temperatures, metal fumes, and other chemical hazards. Knowledge of the composition of metals is very important for safety planning. Though found objects have often been used in the past as budget saving supplies, their use is not safe or appropriate to the classroom. Most heating processes require local exhaust ventilation such as a slot hood. No flammables are to be used or stored anywhere near the area where these heating processes are used.

Due to high risks of electric shock, large amounts of fumes, and potential eye and skin damage, arc welding is not recommended for the art classroom. Oxyacetylene welding should be used only after in-depth training by the instructor. Appropriate securing and care of tanks and lines is essential to classroom safety. Protective clothing and goggles (shade 4 to 8 depending on process) are necessary to the welder. Fireproof work surfaces (non-asbestos) and fireproof wall and floor coverings are also required.

Soldering also requires the use of precautions related to heat and fumes. Local ventilation is required for all soldering operations. Fumes from cadmium containing silver solders can be fatal and therefore should never be found in the classroom. Likewise, the choice of zinc chloride and fluoride fluxes are unsafe choices due to fumes. The soldering problems related to the use of tanks and torches are the same as those discussed above. Protective goggles of at least a shade #4 are required for soldering.

The **fabricating** of metals involves many types of equipment and tools which through cutting and other manipulation processes, produce metal filings and sharp edges on the metals. Goggles for eye protection are always to be worn for these processes. Safe handling of sharp metal pieces often involves securing the metal properly during the work process (clamps) and during storage.

The **finishing** of metals involves various cleaning and polishing processes. For cleaning, sparex should be used rather than more toxic acids or potassium dichromate. If acids are used, they involve safety practices which are discussed below (p. 59). Mechanical techniques involving grinders and buffers must be completed with goggles and face shield (for heavier work). Sandstone grinding wheels can cause silicosis problems and therefore should not be used. Local exhaust ventilation of grinding and buffing equipment is necessary to avoid inhalation of the various materials; equipment guards are a must for safe operation of such power equipment.

The **surface manipulation** of metals can involve chemical, electrical, or mechanical treatments. Engraving tools used for repoussé and chasing must always be used with the tool cutting away from the worker. The heating of pitch and the use of benzine require normal fire precautions and planning. Colorants used to treat metals are of a great variety and are usually applied by paste, dipping, or brushing. Check each chemical process in detail for its individual hazards; local exhaust ventilation is usually required for these chemical processes. In particular, it should be noted that gilding - which involves mercury, and niello - which involves the use of lead, are both highly toxic, and should not be attempted in any secondary classroom.

Etching processes involve acids which must be used with tongs, gloves, goggles, and plastic apron. Acid baths must be vented outside by local exhaust ventilation. An eye wash station and emergency shower are to be available whenever acids are used. Sodium bicarbonate should be available to neutralize acids before disposal. Always cover acid baths when not in use.

Electroplating is rarely available in high schools. The process involves acids (local ventilation needed), large amounts of electricity, and in many cases (i.e. gold and silver), the use of cyanide salts. These cyanide salts should never be used in the classroom as exposure can be fatal.











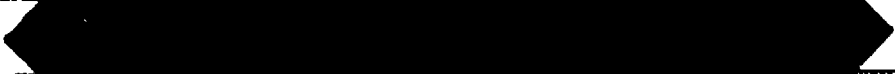

Specific problems of individual metals and their corresponding hazards can be found in McCann's (1979) book, *Artist Beware* on pages 290 - 299.



**METALS
MATERIAL USAGE**

MATERIALS	MATERIAL NOT TO BE USED	LEVELS OF MATERIAL USE			
		TEACHER	SENIOR HIGH	JUNIOR HIGH	ELEMENTARY
CASTING					
Casting materials		X	X		
Centrifuge		X	X		
Crucible		X	X		
Ethyl silicate (slurries)	X				
Furnace		X	X		
Investment plaster: silica (clay grog, cristobalite)	X				
Investments plaster: asbestos	X				
Investment plaster: plaster		X	X		
Investment plaster: powdered pumice		X	X		
Investment plaster: other non-silica		X	X		
Mold release: asbestos	X				
Mold release: asbestos free talc		X	X		
Mold release: French chalk (free silica)	X				
Mold release: graphite		X	X		
Mold release: silica flour	X				
Torch		X	X		
Sand: foundry sand		X	X		









METALS SAFETY CHECKLIST

ART MATERIALS OR EQUIPMENT		APPROPRIATE SAFETY EQUIPMENT		
NOT IN USE	IN USE	CORRESPONDING SAFETY EQUIPMENT AND PRACTICES	IN PLACE	NEEDED
				
		 dust mask (mold breakup)	vacuum or wet mop	
		 protective shield	proper machine balance	
		 infrared goggles shade #1.7 - 3.0	protective wool clothing	
		 insulated leggings	foot covering	
		 infrared goggles shade #1.7 - 3.0	protective wool clothing	
		 insulated leggings	foot covering	
		 vacuum or wet mop		
		 vacuum or wet mop		
		 vacuum or wet mop		
		 vacuum or wet mop		
		 vacuum or wet mop		
		 vacuum or wet mop		
		vacuum or wet mop		
		vacuum or wet mop		
		vacuum or wet mop		
		vacuum or wet mop		
		vacuum or wet mop		
		vacuum or wet mop		
		vacuum or wet mop		
		vacuum or wet mop		
		vacuum or wet mop		
		vacuum or wet mop		
		vacuum or wet mop		
		vacuum or wet mop		
		vacuum or wet mop		
		vacuum or wet mop		
		vacuum or wet mop		
		vacuum or wet mop		
		vacuum or wet mop		
		vacuum or wet mop		
		vacuum or wet mop		
		vacuum or wet mop		
		vacuum or wet mop		
		vacuum or wet mop		
		vacuum or wet mop		
		vacuum or wet mop		
		vacuum or wet mop		
		vacuum or wet mop		
		vacuum or wet mop		
		vacuum or wet mop		
		vacuum or wet mop		
		vacuum or wet mop		
		vacuum or wet mop		
		vacuum or wet mop		
		vacuum or wet mop		
		vacuum or wet mop		
		vacuum or wet mop		
		vacuum or wet mop		
		vacuum or wet mop		
		vacuum or wet mop		
		vacuum or wet mop		
		vacuum or wet mop		
		vacuum or wet mop		
		vacuum or wet mop		
		vacuum or wet mop		
		vacuum or wet mop		
		vacuum or wet mop		
		vacuum or wet mop		
		vacuum or wet mop		
		vacuum or wet mop		
		vacuum or wet mop		
		vacuum or wet mop		
		vacuum or wet mop		
		vacuum or wet mop		
		vacuum or wet mop		
		vacuum or wet mop		
		vacuum or wet mop		
		vacuum or wet mop		
		vacuum or wet mop		
		vacuum or wet mop		
		vacuum or wet mop		
		vacuum or wet mop		
		vacuum or wet mop		
		vacuum or wet mop		
		vacuum or wet mop		
		vacuum or wet mop		
		vacuum or wet mop		
		vacuum or wet mop		
		vacuum or wet mop		
		vacuum or wet mop		
		vacuum or wet mop		
		vacuum or wet mop		
		vacuum or wet mop		
		vacuum or wet mop		
		vacuum or wet mop		
		vacuum or wet mop		
		vacuum or wet mop		
		vacuum or wet mop		
		vacuum or wet mop		
		vacuum or wet mop		
		vacuum or wet mop		
		vacuum or wet mop		
		vacuum or wet mop		
		vacuum or wet mop		
		vacuum or wet mop		
		vacuum or wet mop		
		vacuum or wet mop		
		vacuum or wet mop		
		vacuum or wet mop		
		vacuum or wet mop		
		vacuum or wet mop		
		vacuum or wet mop		
		vacuum or wet mop		
		vacuum or wet mop		
		vacuum or wet mop		
		vacuum or wet mop		
		vacuum or wet mop		
		vacuum or wet mop		
		vacuum or wet mop		
		vacuum or wet mop		
		vacuum or wet mop		
		vacuum or wet mop		
		vacuum or wet mop		
		vacuum or wet mop		
		vacuum or wet mop		
		vacuum or wet mop		
		vacuum or wet mop		
		vacuum or wet mop		
		vacuum or wet mop		
		vacuum or wet mop		
		vacuum or wet mop		
		vacuum or wet mop		
		vacuum or wet mop		
		vacuum or wet mop		
		vacuum or wet mop		
		vacuum or wet mop		
		vacuum or wet mop		
		vacuum or wet mop		
		vacuum or wet mop		
		vacuum or wet mop		
		vacuum or wet mop		
		vacuum or wet mop		
		vacuum or wet mop		
		vacuum or wet mop		
		vacuum or wet mop		
		vacuum or wet mop		
		vacuum or wet mop		
		vacuum or wet mop		
		vacuum or wet mop		
		vacuum or wet mop		
		vacuum or wet mop		
		vacuum or wet mop		
		vacuum or wet mop		
		vacuum or wet mop		
		vacuum or wet mop		
		vacuum or wet mop		
		vacuum or wet mop		
		vacuum or wet mop		
		vacuum or wet mop		
		vacuum or wet mop		
		vacuum or wet mop		
		vacuum or wet mop		
		vacuum or wet mop		
		vacuum or wet mop		
		vacuum or wet mop		
		vacuum or wet mop		
		vacuum or wet mop		
		vacuum or wet mop		

METALS MATERIAL USAGE

MATERIALS	MATERIAL NOT TO BE USED	LEVELS OF MATERIAL USE			
		TEACHER	SENIOR HIGH	JUNIOR HIGH	ELEMENTARY
Sand: resin binder	X				
Sand: silica	X				
Styrofoam process materials (hydrogen cyanide)	X				
Wax		X	X	X	
HEATING PROCESSES					
Arc welding	X				
Cylinders: acetylene		X	X		
Cylinders: oxygen		X	X		
Flux		X	X	X	
Flux, fluoride, zinc chloride	X				
Oxyacetylene welding equipment		X	X		
Solder		X	X	X	
Solder: cadmium containing	X				
Soldering materials: hard / brazing		X	X		
Soldering materials: soft		X	X	X	
Soldering iron		X	X	X	













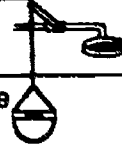

METALS SAFETY CHECKLIST

ART MATERIALS OR EQUIPMENT		APPROPRIATE SAFETY EQUIPMENT		
NOT IN USE	IN USE	CORRESPONDING SAFETY EQUIPMENT AND PRACTICES	IN PLACE	NEEDED
		(if heated use) temperature controlled hotplate & double boiler		
				
		chained tanks clean fittings (no oil or grease) no flammables		
		store separate from oxygen pressure reducing regulator or valve		
		(see acetylene above) store with valve up		
		 GV		
		LE  protective wool clothing shade #4 - 8		
		fireproof wall and floor covering well-fastened cylinders		
		alumina-fire brick work surface no flammables friction lighter		
		 100 ft / minute movable exhaust OR 		
		 GV		
		  shade #4 (see cylinders above)		
				
		fire resistant work surface and rest for iron		

**METALS
MATERIAL USAGE**

MATERIALS	MATERIAL NOT TO BE USED	LEVELS OF MATERIAL USE			
		TEACHER	SENIOR HIGH	JUNIOR HIGH	ELEMENTARY
FABRICATING					
Acids: nitric, sulfuric		X	X		
Acid baths		X	X		
Forging materials		X	X		
Furnaces		X	X		
Metalworking equipment: (drills, saws, etc.)		X	X	X	
Sparex		X	X	X	
METAL FINISHING					
Acids: nitric, sulfuric		X	X		
Buffer		X	X	X	
Caustic soda	X				
Cutting oil: amines, nitrites	X				
Cutting oil: other		X	X		
Grinder		X	X	X	
Grinding wheels: alumina		X	X	X	
Grinding wheels: sandstone	X				
Grinding wheels: silicone carbide		X	X	X	



METALS SAFETY CHECKLIST

ART MATERIALS OR EQUIPMENT		APPROPRIATE SAFETY EQUIPMENT		
NOT IN USE	IN USE	CORRESPONDING SAFETY EQUIPMENT AND PRACTICES	IN PLACE	NEEDED
		   		
		acid bath cover fume hood sodium bicarbonate (neutralizer)		
		tongs sign "Caution Acid Area" sign "Gloves and Goggles Must Be Worn"		
		fireproof sound absorbing materials (ceiling, walls) separate room		
		see "furnaces" below for hot forging ear muffs / ear plugs		
		chimney (exhaust fan) LE  protective clothing		
		GV  (cooled air) infrared shields  shade #1.7 - 3.0		
		 equipment guards proper grounding		
		 		
		(see "Acids" and "Acid Baths" above on this page)		
		  safety guard		
		 protective clothing		
		  safety guard		
		(see "grinder" above)		
		(see "grinder" above)		

METALS MATERIAL USAGE

MATERIALS	MATERIAL NOT TO BE USED	LEVELS OF MATERIAL USE			
		TEACHER	SENIOR HIGH	JUNIOR HIGH	ELEMENTARY
Potassium dichromate	X				
Sandblasting: silica	X				
Sandblasting: carborundum		X	X		
Sparex (sodium bisulfate)		X	X	X	
METALS					
Aluminum		X	X		
Beryllium	X				
Brass	X				
Brittania (white) metal	X				
Bronze (non-lead)		X	X		
Cadmium	X				
Chromium	X				
Copper		X	X	X	
Found metals (unknown composition)	X				
Galvanized metal	X				
Gold		X	X		
Iron		X			
Lead	X				
Manganese	X				
Nickle	X				

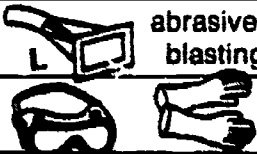





METALS SAFETY CHECKLIST

ART MATERIALS OR EQUIPMENT		APPROPRIATE SAFETY EQUIPMENT		
NOT IN USE	IN USE	CORRESPONDING SAFETY EQUIPMENT AND PRACTICES	IN PLACE	NEEDED
		 abrasive blasting hood protective clothing		
				
		see process		
		see process		
		see process		
		see process		
		see process		

METALS MATERIAL USAGE

MATERIALS	MATERIAL NOT TO BE USED	LEVELS OF MATERIAL USE			
		TEACHER	SENIOR HIGH	JUNIOR HIGH	ELEMENTARY
Nickel silver (copper, zinc, nickel)	X				
Pewter (lead alloy or antimony alloy)	X				
Silver		X	X		
Steel: mild		X	X		
Steel: stainless (iron & nickel)	X				
Zinc		X	X		
SURFACE MANIPULATION					
Acids - etching (see "Acids" and "Acid Baths" p. 64)					
Caustic soda	X				
Cyanide salts	X				
Colorants: barium sulfide, lead acetate, platinum chloride, glacial acetic acid, hydrochloric acid, iodine, sodium hydroxide, sodium thiosulfate, zinc chloride	X				
Colorants: ammonium chloride, ammonium sulfate, ammonium sulfide, copper carbonate, copper nitrate, potassium sulfide (liver of sulfur)		X	X		
Electroplating materials (non-cyanide)		X	X		
Engraving tools		X	X		
Gilding materials: (mercury, and gold or silver)	X				
Niello materials (lead)	X				

METALS SAFETY CHECKLIST

ART MATERIALS OR EQUIPMENT		APPROPRIATE SAFETY EQUIPMENT		
NOT IN USE	IN USE	CORRESPONDING SAFETY EQUIPMENT AND PRACTICES	IN PLACE	NEEDED
		see process		
		see process		
		see process		
				
		   		
		approved waste disposal can		
		 		
		sharpening equipment (avoid slipping)	safety cover (for shocks) during plating	

Photography: Hazards and Precautions

Photography materials are used in a variety of courses and activities in the schools today. Courses offered by the industrial arts, communications, science, or art departments often include photographic processes. Co-curricular activities such as the school newspaper, yearbook, programs in local history documentation, and the literary arts magazine, may also use photographic materials. In many cases, the individuals responsible for these co-curricular activities may have little or no experience with chemical use and safety.

Many chemical processes are far too hazardous to warrant their use in the elementary, junior high, and in many cases, in the high school setting. Numerous photographic processes, with proper precautions, are acceptable in secondary settings. The making of contact prints on prepared blue print paper is a safe process which can be used to teach children about light sensitive materials. Photo processes involving chemistry should not be attempted with elementary students; for example, the photos taken by fourth grade students on the class's weekend camping trip should be developed by a commercial lab.

In recent years, **alternative photographic processes** have again become popular, particularly for the variety of colors and textures they can produce. Because the photographer must handle liquid emulsions, involving chemicals that are rather toxic, these processes should be reserved for students in advanced high school photography classes.

Because of long exposure times for the emulsions of the alternative processes, individuals often consider using carbon arc lamps. Fumes and gases from carbon arc lamps are highly toxic by inhalation. These fumes and gases, electrical concerns, and harmful amounts of ultraviolet light make carbon arc lamps a poor choice in any classroom. The use of sunlight or other auxiliary lighting is a much safer option. Certain processes such as cyanotype must still be ventilated during exposure under ultraviolet light, because of the release of hydrogen cyanide gas. Therefore, exposure of cyanotypes in the sunlight is a good option.

Daguerreotype (problems with highly toxic mercury vapors) and the gum bichromate process (causing skin allergies and ulcers) are not recommended because of their potential for damaging the human body. In the vandyke process, gloves and goggles must be worn to protect the skin and eyes from silver nitrate. Photographic screen printing can be done without many problems if the least toxic, diazo photo emulsions are chosen. Xerography processes do not usually involve any direct contact with the chemicals, and if used with adequate ventilation, are relatively safe. Detailed sources, such as Seeger's *A Photographer's Guide to the Safe Use of Materials* (1983) and Shaw's *Overexposure: Health Hazards in Photography* (1983), should be examined with care before students or instructor work with any new photographic process.

Color processes are again an unwise choice for even the high school classroom. If color processes are used by advanced photography students, local exhaust ventilation is essential. In particular, Cibachrome's highly toxic chemicals and questionable effects on the human body should be avoided. Other individual color processes involve chemicals which must be ventilated and handled with special care.

Chemicals used in **black and white photographic processes** are the most commonly found photo chemicals in the school setting; these materials must also be used with appropriate safety precautions. Mixing of chemical baths from concentrated solutions or powders should be done only by the instructor who is well informed of the safety procedures and equipment related to each solution. Powdered developers must be mixed using local exhaust ventilation or an approved dust

respirator (teacher only). In addition, an emergency shower should be available wherever photo chemicals are being mixed. Standard black and white developers, stop bath, and fixer should be used with tongs, gloves, and dilution ventilation (20 air exchanges / hour). Covers for chemical baths should also be provided when materials are not in use. Eye wash fountains should be available in any darkroom in order to facilitate prompt treatment of chemical splashes.

Other chemicals related to black and white photographic processes can also pose potential hazards. Intensifiers and reducers, used to treat negatives, are sometimes composed of uranium nitrate, potassium cyanide, and mercury solutions, or potassium ferricyanide, and involve skin corrosion and poisoning hazards which do not warrant their use. Farmer's Reducer, which contains potassium ferricyanide, is safe under normal conditions, but it produces cyanide if heated, if exposed to ultraviolet radiation (e.g. carbon arc lamps), or if acid is added.

Most toners are safe when used with local ventilation; however, thiourea, a suspected carcinogen, should not be used in any classroom. Sulfide, brown, or sepia toners give off highly poisonous hydrogen sulfide gas, while selenium toner causes concern because of its sulfur dioxide. Therefore, these commonly used toners must be used with a fume hood or slot hood ventilation system.

Because of the variety of photographic chemicals, and the lack of safety information on the packaging from many photographic chemical suppliers, it is suggested that any instructor using photographic chemistry obtain a Material Safety Data Sheet for each chemical to be used. In this way, technical hazard information will always be on hand.















Note that for any photographic process involving chemicals, students with contact lenses should wear **sealed** goggles treated with an anti-fogging solution. Likewise, the use of hooded ventilated goggles by other individuals is a good practice with any photo chemical or chemical bath.



PHOTOGRAPHY MATERIAL USAGE

MATERIALS	MATERIAL NOT TO BE USED	LEVELS OF MATERIAL USE			
		TEACHER	SENIOR HIGH	JUNIOR HIGH	ELEMENTARY
ALTERNATIVE PROCESSES					
Blue print paper (prepared)		X	X	X	X
Carbon arc lamp	X				
Cyanotype materials (liquid)		X	X	X	
Cyanotype (exposure)		X	X	X	
Daguerreotype materials	X				
Graphic arts film / ortho developer		X	X		
Gum bichromate materials	X				
Kwik print		X	X		
Photo screen printing (diaz) emulsions		X	X	X	
Sunlamp or other artificial light source		X	X	X	X
Vandyke brown materials		X	X		
Xerography: black & white		X	X	X	
Xerography: color		X	X	X	
COLOR					
Airbrush materials: solvent based	X				
Airbrush materials: water based		X	X		
Bleach		X	X		
Bleach 2 - ethoxy ethanol	X				
Cibachrome	X				





















PHOTOGRAPHY SAFETY CHECKLIST

ART MATERIALS OR EQUIPMENT		APPROPRIATE SAFETY EQUIPMENT		
NOT IN USE	IN USE	CORRESPONDING SAFETY EQUIPMENT AND PRACTICES	IN PLACE	NEEDED
				
		←		
		sunlight exposure		
		 		
		sunlight exposure		
		exhaust fan tongs OR 		
		 GV		
		 (see also "Silkscreening" pp. 88 - 91 for information on inks and other silkscreen materials)		
		 L   plastic apron		
		 GV		
		 GV		
		←		
				
				
		 GV		

PHOTOGRAPHY MATERIAL USAGE

MATERIALS	MATERIAL NOT TO BE USED	LEVELS OF MATERIAL USE			
		TEACHER	SENIOR HIGH	JUNIOR HIGH	ELEMENTARY
Color processing chemicals		X	X		
Developers: monomethyl-p aminophenol sulfate and hydroquinone (dry or liquid concentrate)		X			
Formaldehyde	X				
Penetrating solvents: benzyl alcohol, ethylene alcohol		X	X		
Succinaldehyde	X				
Tertiary butylamine	X				
BLACK & WHITE					
Alum - hardener (potassium aluminum sulfate)		X	X	X	
Accelerators: borax, powdered		X			
Accelerators: sodium carbonate		X	X		
Accelerators: sodium hydroxide		X	X		
Accelerators: alkalis (pure)	X				
Boric acid (buffer)		X	X		
Chemical baths (for all black and white processing)		X	X	X	
Developer: hydroquinone, phenidone monomethyl Para -aminophenol sulfate		X	X		
Developers: powdered		X			











PHOTOGRAPHY SAFETY CHECKLIST

ART MATERIALS OR EQUIPMENT		APPROPRIATE SAFETY EQUIPMENT		
NOT IN USE	IN USE	CORRESPONDING SAFETY EQUIPMENT AND PRACTICES	IN PLACE	NEEDED
		  fountain tongs chemical storage and chemical bath covers		
		   for powders		
		 		
				
		  		
		  plastic apron		
		  plastic apron		
				
		eyewash  covers for chemical baths tongs		
		good ventilation: 20 air changes / hour  for mixing		
		(see form below)		
		   OR fume hood plastic apron		

PHOTOGRAPHY MATERIAL USAGE

MATERIALS	MATERIAL NOT TO BE USED	LEVELS OF MATERIAL USE			
		TEACHER	SENIOR HIGH	JUNIOR HIGH	ELEMENTARY
Developers: liquid concentrate		X			
Fixer: hypo - (sodium thiosulfate), acetic acid		X	X	X	
Freons (fluorocarbons)		X	X		
Intensifiers: dichromate	X				
Intensifiers: mercuric chloride, mercury oxide, potassium cyanide, uranium nitrate	X				
Mixing tanks		X	X		
<i>Para</i> -phenylenediamine & derivatives	X				
Potassium bromide (restrainer antifog agent)		X			
Sodium sulfite (developer preservative)		X	X	X	
Reducer (Farmer's)		X	X		
Stop bath: acetic acid (diluted)		X	X	X	
Stop bath: concentrates		X			
Stop bath: potassium chrome alum or chrome alum (diluted)		X	X	X	
Toners: sulfide, selenium		X	X		
Toners: thiourea	X				

PHOTOGRAPHY SAFETY CHECKLIST

ART MATERIALS OR EQUIPMENT		APPROPRIATE SAFETY EQUIPMENT		
NOT IN USE	IN USE	CORRESPONDING SAFETY EQUIPMENT AND PRACTICES	IN PLACE	NEEDED
		 plastic apron		
		 dilution ventilation 20 air exchanges / hour		
		 GV		
				
		 OR fume hood		
				
				
		 dilution ventilation 20 air exchanges / hour		
				
		 dilution ventilation 20 air exchanges / hour		
				

Printmaking: Hazards and Precautions

In general, printmaking processes should be executed using water-based rather than oil based inks. Use inks and other printmaking materials in the elementary schools that are approved by the California State Department of Health Services. Whenever possible, use these materials in the secondary schools as well. Certain processes requiring the use of oil-based inks and solvents should be reserved for high school programs.

Printmaking **solvents** must be stored in appropriate safety containers in a flammable storage cabinet. These solvents should always be closed when not in use, so as to reduce fumes in the classroom. Self-closing safety disposal containers are to be used for all rags and paper materials. These containers are to be emptied and properly disposed of every day. Use the least hazardous solvent for each process. No open fires are to be allowed when solvents are being used in the work area.

Intaglio printmaking includes processes where ink is transferred to paper from areas below the printing plate surface. Numerous solvents, solutions, and acids are used for intaglio processes which can pose significant health problems. Therefore, intaglio processes such as engraving, drypoint, and etching should be limited to the high school setting. Certain highly toxic chemicals such as xylene found in etching grounds should not be used at all in the school setting. Acids used for etching baths must be handled with much care, using rubber gloves, goggles, and protective clothing. These baths must be properly vented to the outdoors. For acid processes, a neutralizing agent such as sodium bicarbonate should always be available in addition to an eyewash station and an emergency shower. Acid baths should be totally covered or emptied into an appropriate bottle at the end of the work period. For aquatinting, special care must be used in handling rosin dust which is explosive. No sparks or open flames should be found in the work space when rosin is being used in a rosin box. Rosin boxes must be explosion proof.

Sharp cutting tools such as those used for engraving and drypoint should always be used with the tool cutting away from the body and hands.

Lithography is a process involving oil based ink and water resist on stone or metal plates. This process, though often not available in the school setting, can be found in some high schools. Stone and metal plate processing should only be attempted with extensive safety training. Due to the high risks involved in the use of carbon arc lamps, developers, and ammonia, photolithographic processes are inappropriate to the classroom.

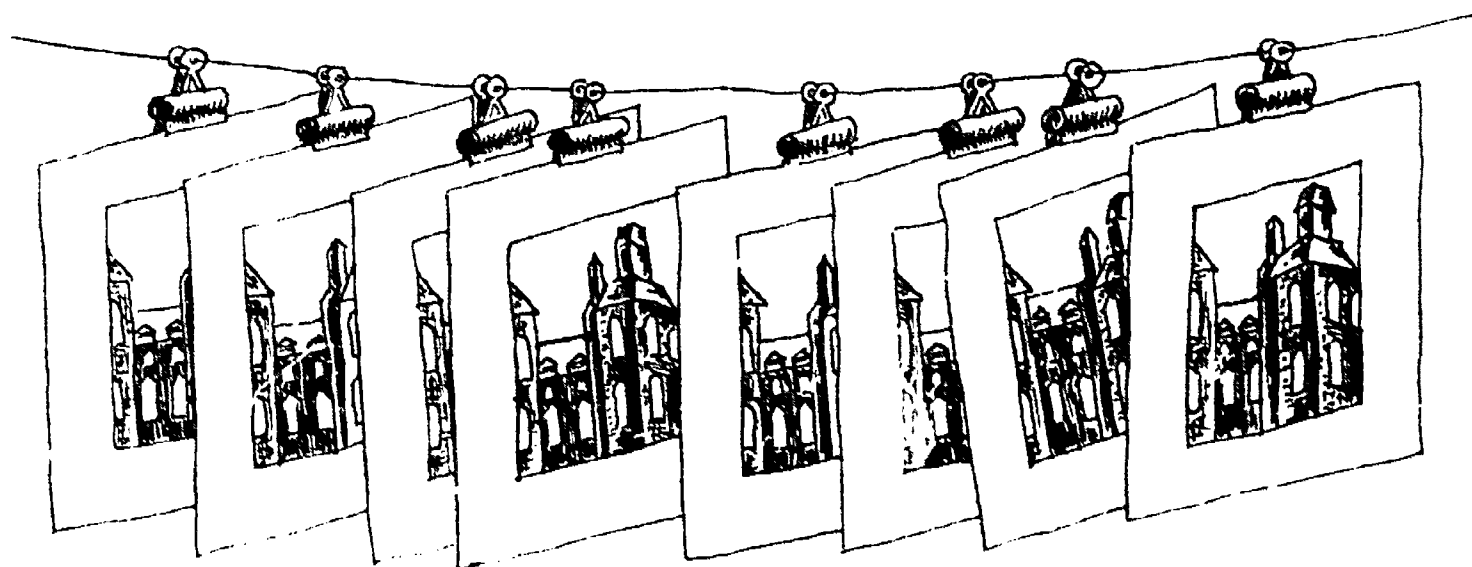

Relief printmaking is the most commonly found process in the schools. Linocuts, collagraphs, and woodcuts are often used in addition to found object prints (potato, cardboard, etc.) Using a process appropriate to the age, relief printing may be done safely with elementary, junior high, and high school students.

"Pull-type" cutters (such as linozips) are a safer alternative for cutting relief surfaces. If "push-type" cutters are used, cutting should be done with the tool cutting away from the student's body and hands. Working with a press with secondary age students involves giving detailed safety instructions concerning the rollers, and the constant monitoring of the printing process by the instructor.

Water soluble block printing inks are available which are approved by the California State Department of Health Services. If these water-based inks are used, hazards are for the most part limited to the mechanical aspects of the relief processes. However, several special hazards should be avoided in relief printmaking. Glues for collagraphs should be water-based as opposed to the more toxic, solvent-based glues which are often used. Collagraphs should be sealed with acrylic emulsions rather than spray fixatives which are highly hazardous by inhalation. If these acrylic surfaces are sanded, this should be done in a fume hood. In addition, the etching of linoleum with caustic soda is far too risky for use in any classroom.

Silkscreen printing is fairly popular in the secondary schools. The hazards involved in the use of these stencil techniques are being reduced as safer materials have become available that were initially developed for industrial settings. Use only water-based or acrylic inks. Silkscreen inks are available which are approved by the California State Department of Health Services and should be the only choice for elementary students. Epoxy, poster, and vinyl inks, solvent based thinners, retarders, and wash-ups are highly toxic by skin contact and inhalation, and therefore should not be used in even the most advanced classes. Again, use of these toxic materials can be avoided by using water based inks.

In addition, significant hazards are found in adhering and removing stencil materials. Stencils involving little or no hazard include cut paper stencils, thermofax stencils, or friskets applied in reverse. Photo diazo emulsions exposed on a light table are also a good choice. Highly toxic lacquers and thinners used with lacquer stencils contain aromatic hydrocarbons which are highly toxic by inhalation; they should not be used in the classroom.

















PRINTMAKING MATERIAL USAGE

MATERIALS	MATERIAL NOT TO BE USED	LEVELS OF MATERIAL USE			
		TEACHER	SENIOR HIGH	JUNIOR HIGH	ELEMENTARY
PRINTMAKING (General)					
Inks: Oil based		X	X		
Inks: pigment powders	X				
Inks: ready-made		X	X	X	X
Inks: water based		X	X	X	X
INTAGLIO					
Acids: acetic, nitric, tannic hydrochloric, phosphoric		X	X		
Acid: carbolic (phenol)	X				
Acid baths		X	X		
Alcohol		X	X		
Asphaltum		X	X		
Benzine		X	X		
Burin		X	X		
Etching ink		X	X	X	X
Etching medium		X	X	X	X
Ground - hard		X	X		
Ground - soft		X	X		
Lamps - carbon arc	X				
Lamps - metal halide, quartz mercury		X	X		

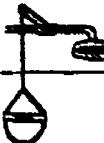

Indicates that the material is available in a product form considered to be safe for children by the California State Department of Health Services.





PRINTMAKING SAFETY CHECKLIST

ART MATERIALS OR EQUIPMENT		APPROPRIATE SAFETY EQUIPMENT			
NOT IN USE	IN USE	CORRESPONDING SAFETY EQUIPMENT AND PRACTICES	IN PLACE	NEEDED	
		 			
					
					
		   	plastic apron 		
		acid bath cover	fume hood	sodium bicarbonate (neutralizer)	
		tongs	sign "Caution Acid Area"	sign "Gloves and Goggles MUST be Worn"	
			OR barrier cream	baby oil for hand cleaning	
					
		cut away from body			
			OR barrier cream		
			OR barrier cream		
				baby oil for hand cleaning	
				baby oil for hand cleaning	

PRINTMAKING MATERIAL USAGE

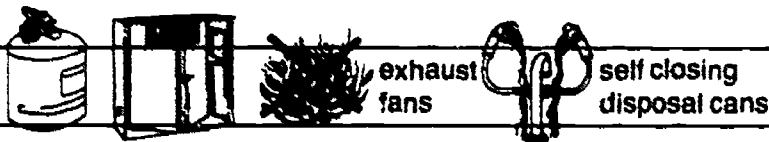
MATERIALS	MATERIAL NOT TO BE USED	LEVELS OF MATERIAL USE			
		TEACHER	SENIOR HIGH	JUNIOR HIGH	ELEMENTARY
Open fire - smoking ground	X				
Mineral spirits		X	X		
Photoresist	X				
Photoetching dyes, developers	X				
Potassium chlorate	X				
Solvents		X	X		
Spray enamel paints		X	X		
Stop-outs: brand name		X	X		
Stop-outs: rosin / alcohol; asphaltum / mineral spirits		X	X		
Rosin - powdered		X	X		
Xylene	X				
LITHOGRAPHY					
Acids (see "Acids" and "Acid Baths" pp. 82 - 83)					
Asphaltum liquid		X	X		
Benzine		X	X		
Chrome alum	X				
Counteretches - acetic acid		X	X		
Counteretches - saturated alum	X				
Dichromates	X				

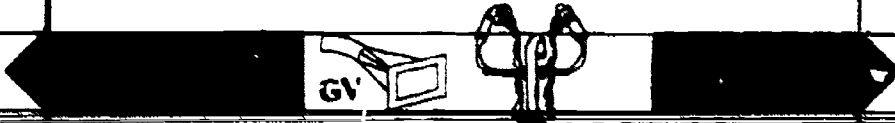
PRINTMAKING SAFETY CHECKLIST

ART MATERIALS OR EQUIPMENT		APPROPRIATE SAFETY EQUIPMENT		
NOT IN USE	IN USE	CORRESPONDING SAFETY EQUIPMENT AND PRACTICES	IN PLACE	NEEDED
		 (see specific solvent pp. 40 - 43)		
		fume hood or outdoors		
				
		spark proof rosin bag	wet mop	
				
			baby oil for hand clean up	
				







PRINTMAKING MATERIAL USAGE

MATERIALS	MATERIAL NOT TO BE USED	LEVELS OF MATERIAL USE			
		TEACHER	SENIOR HIGH	JUNIOR HIGH	ELEMENTARY
Gasoline	X				
Gum arabic		X	X	X	
Lamp black (pure)	X				
Lamps (see "Intaglio" pp 82 - 85)					
Lithographic crayons & pencils		X	X		
Lithotine		X	X		
Mineral spirits		X	X	X	
Photolitho graphic developers	X				
Photosensitive emulsions: diazo		X	X	X	
Plat conditioners: alkalis	X				
Solvents (general)		X	X	X	
Tusche: lithographic		X	X		
Talc: asbestos free		X	X		
Talc: French chalk	X				
Vinyl lacquer plate bases	X				
RELIEF					
Block printing ink, water soluble 		X	X	X	X
Caustic soda	X				
Collagraph plates		X	X	X	







Indicates that the material is available in a product form considered to be safe for children by the California State Department of Health Services.

PRINTMAKING SAFETY CHECKLIST

ART MATERIALS OR EQUIPMENT		APPROPRIATE SAFETY EQUIPMENT		
NOT IN USE	IN USE	CORRESPONDING SAFETY EQUIPMENT AND PRACTICES	IN PLACE	NEEDED
				
				
		 exhaust fans		
		 self closing disposal cans		
		(see specific solvent pp. 40 - 43)		
		 		
		wet mop		
				
		sand in fume hood		



















PRINTMAKING MATERIAL USAGE

MATERIALS	MATERIAL NOT TO BE USED	LEVELS OF MATERIAL USE			
		TEACHER	SENIOR HIGH	JUNIOR HIGH	ELEMENTARY
Etching resist: asphaltum		X	X		
Etching resist: paraffin wax		X	X	X	
Etching resist: varnish		X	X		
Glue: organic solvent		X	X		
Glue: cyanocrylate instant glues		X	X		
Glue: water based		X	X	X	X
Linoleum cutting tools		X	X	X	X
Solvents (general)		X	X	X	
Stop-outs		X	X		
Waterproofing solution: acrylic medium		X	X	X	X
Waterproofing solution: shellac / denatured alcohol		X	X		
Waterproofing solution: spray fixative		X	X		
Wood cutting tools: knives, gouges		X	X	X	
Wood		X	X	X	
SILKSCREEN					
Drawing fluids / fillers		X	X	X	X
Epoxy hardeners	X				
Ink: acrylic		X	X	X	X
Ink: epoxy	X				





Indicates that the material is available in a product form considered to be safe for children by the California State Department of Health Services.

PRINTMAKING SAFETY CHECKLIST

ART MATERIALS OR EQUIPMENT		APPROPRIATE SAFETY EQUIPMENT		
NOT IN USE	IN USE	CORRESPONDING SAFETY EQUIPMENT AND PRACTICES	IN PLACE	NEEDED
				
		double boiler	temperature controlled hot plate	
		 		
		   		
		sharpening equipment (avoid slipping)	bench hook or clamps	cut away from body
		    self closing disposal cans		
		(see specific solvent pp. 40 - 43)		
				
				
		 explosion proof		
		sharpening equipment (avoid slipping)	bench hook or clamp	cut away from body
		vacuum or wet mop		
		   		
				









PRINTMAKING MATERIAL USAGE

MATERIALS	MATERIAL NOT TO BE USED	LEVELS OF MATERIAL USE			
		TEACHER	SENIOR HIGH	JUNIOR HIGH	ELEMENTARY
Ink: poster 	X				
Ink: solvent based textile	X				
Ink: vinyl (isophorone)	X				
Ink: water soluble 		X	X	X	X
Ink: water based textile 		X	X	X	X
Modifiers: solvent based	X				
Modifiers: water soluble		X	X	X	
Stencils: caustic enamels, lacquer, polyurethane varnishes	X				
Stencils: cut paper, friskets, thermofax stencils		X	X	X	X
Stencils: liquid wax, shellac, tusche		X	X		
Stencils: water soluble glues and emulsions		X	X		
Thinners: lacquer thinner	X				
Thinners: mineral spirits		X	X	X	
Photo stencils: unsensitized (ammonium dichromate)	X				
Photo stencils: presensitized		X	X	X	



Indicates that the material is available in a product form considered to be safe for children by the California State Department of Health Services.

PRINTMAKING SAFETY CHECKLIST

ART MATERIALS OR EQUIPMENT		APPROPRIATE SAFETY EQUIPMENT		
NOT IN USE	IN USE	CORRESPONDING SAFETY EQUIPMENT AND PRACTICES	IN PLACE	NEEDED
		 GV		
		 GV		
		 GV  		
		 GV 		
		 GV		

Sculpture: Hazards and Precautions

Few sculptural processes other than those involving ceramic clay, cut paper and cardboard, or found object assemblages are attempted in the elementary grades. Carving tools and power equipment used in other processes are best reserved for secondary schools.

Various **clays** are commonly used at all classroom levels. Modeling clays, modeling dough, and self-hardening clays can all be purchased that have been approved by the California State Department of Health Services. For information related to doing sculpture with ceramic clay, see pages 26 - 33 of this work.

Plaster, Plaster of Paris, Hydrocal, and other such plaster mixes are all composed of gypsum (calcium sulfate). Plaster is relatively safe for use in the secondary schools and is often chosen for its fairly low cost as a sculptural material. Dust masks are to be worn while mixing and later sanding plaster. Wet mop techniques are always to be used for cleanup as opposed to sweeping. Additives, such as sand, silica sands, and vermiculite cause significant inhalation hazards and are therefore not recommended.

The carving of plaster must be done with all students wearing safety goggles. Carving should always be done with the tools carving away from the body. Plaster finishing is done with a variety of paints and other finishing materials. Spray finishes of any type (inhalation hazard) and powdered pigments and dyes (skin contact hazard) are unwise choices for the classroom.

Casting can be done with plaster using a variety of mold materials with relatively few problems. But one should not do body casting with plaster of paris because of the risk of severe burns. Junior or senior high school students can use pariscraft (gauze impregnated with plaster of paris) for body casting under careful supervision. Mold releases for plaster that contain benzene are highly toxic by skin contact and inhalation and therefore should not be used. Rather, use mineral oil, petroleum jelly, green soap, or vaseline as mold releases.

Plastic resins pose great risks to any user because the materials change chemically as they are used. The use of plastic resins is not recommended in any school setting because of the high risks of inhalation, ingestion, and skin contact hazards by the user.

With care, some **finished plastics** can be used with few problems. Heat decomposition can occur when working with a hot wire cutting tool and other machine processes for plastics. This decomposition can often involve great risks to the respiratory system and the body's internal organs. If used in the school setting, the plastic materials should be used with local exhaust ventilation or water/air cooled tools. Wet mopping rather than sweeping should be used to clean up plastic dusts.

Stone carving is occasionally done in the school setting, but due to the amount of time involved in the process, it is usually only found in high school classes. Any stone carving is to be done with goggles. In addition to the hazards of flying chips produced during the carving process, dusts produced during carving can create great risks. Stone is to be asbestos free; other toxic minerals should also be avoided. Soft stones can be carved by hand but hard stones such as granite and some marbles, require the use of power equipment. Due to vibration, intense noise, and huge amounts of dust, pneumatic tools often used for carving stone are not recommended for the school setting.

Stone casting materials are not recommended for the classroom as cement and sand contain silica which is highly toxic by inhalation. Grinding and sanding processes for stone also can produce dusts, especially when power equipment is used. Use wet processes whenever possible to reduce these air-borne dusts. Local exhaust ventilation is again required with these finishing processes to avoid silicosis.

The major problems of using wax involve the decomposition or explosion of the material when it is overheated, and the hazards of solvents used in combination with the wax. Always heat wax in a double boiler on a temperature controlled hot plate. As exposure to carbon tetrachloride can be fatal, it should never be used as a solvent in the classroom setting. Use less toxic wax solvents such as mineral spirits, alcohol, or acetone to dissolve the wax if required.

Wood materials are often found in the schools for use in three-dimensional constructions such as craft projects and sculpture. In many cases, wood scrap from local industry is used as a cost efficient material in even elementary classrooms. With young children, the use of wood should be limited to assemblages involving non-toxic glues. In secondary settings, there is often access to power equipment which can pose dangers of noise, dust, and cutting hazards.

Individual sensitivity and allergies to woods are more likely with tropical woods or green (freshly cut) wood materials and should be avoided. Pressure-treated woods, often treated with highly toxic chromated copper arsenate, should not be used in any classroom.

To reduce dust, any machines used with wood are to be equipped with local ventilation systems, and for more sensitive students, a dust mask is in order. All machines are to have safety guards in place, be properly maintained, and only used in the presence of an instructor. Goggles, and in the case of a lathe, a face shield, are to be used for proper personal protection. Training in the safe use of power equipment is the responsibility of the classroom instructor, even when he/she sends the student to the woodworking instructor, in another part of the building, to cut a piece of wood on the bandsaw. Any student planning to use a piece of power equipment should pass both a written and a practical exam for that specific piece of equipment before being allowed to work with such equipment.

Particle board and plywood release formaldehyde as they are machined. With these wood products, dust collectors must be used and exhausted to the outside of the building when the wood is machined in the classroom. Such decomposition products are not to be recirculated within the school building.

Glues used for wood can be hazardous as well. Risks involved with formaldehyde-resin glues (eye contact and inhalation risks), and contact adhesives containing hexane (inhalation hazard) do not warrant their use. Avoid the use of solvent-based glues and use water-based glues whenever possible. Cyanocrylate glues or instant glues can cause the glueing together of the skin and therefore should only be used by high school students after careful instruction from the teacher.

Paint and varnish removers occasionally appear in the classroom. Any of these products containing methylene chloride (inhalation hazard and heart problems) are not to be used in the classroom. Other varieties should be used with caution. The finishing of wood completed with natural oils poses few problems. Do not use any spray finishes unless a spray booth is available; these air-borne particulates pose great risk by inhalation.

SCULPTURE MATERIAL USAGE

MATERIALS	MATERIAL NOT TO BE USED	LEVELS OF MATERIAL USE			
		TEACHER	SENIOR HIGH	JUNIOR HIGH	ELEMENTARY
CLAY MATERIALS					
Ceramic clay (see pp 26 - 33)					
Modeling clay: permanently plastic (non-hardening)		X	X	X	X
Modeling dough		X	X	X	X
Papier Mache		X	X	X	X
Powdered sculpturing and modeling media		X	X	X	X
Self-hardening clay		X	X	X	X
Self-mixed clay	X				
Talc: asbestos	X				
Talc: asbestos free		X	X		
PLASTER					
Acetic acid	X				
Additives: coarse stone		X	X		
Additives: sand, silica sands	X				
Additives: vermiculite	X				
Borax		X	X	X	
Burnt lime (calcium oxide)	X				
Carving tools: chisel, knives, rasps, scrapers		X	X	X	
Mold releases: mineral oil, petroleum jelly, tincture of green soap, vaseline		X	X	X	



Indicates that the material is available in a product form considered to be safe for children by the California State Department of Health Services.

SCULPTURE SAFETY CHECKLIST

ART MATERIALS OR EQUIPMENT		APPROPRIATE SAFETY EQUIPMENT		
NOT IN USE	IN USE	CORRESPONDING SAFETY EQUIPMENT AND PRACTICES	IN PLACE	NEEDED
			sharpening equipment (avoid slipping)	carve away from body













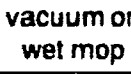

SCULPTURE MATERIAL USAGE

MATERIALS	MATERIAL NOT TO BE USED	LEVELS OF MATERIAL USE			
		TEACHER	SENIOR HIGH	JUNIOR HIGH	ELEMENTARY
Mold releases: paste wax, benzine; silicone / grease / benzine	X				
Paint, finishes, solvents (see pp. 38 - 43)					
Patinas: white glue, lacquer and alcohol, bronzing liquid		X	X		
Plaster (calcium sulfate) with no preservatives		X	X	X	
Potassium alum		X	X		
Potassium sulfate		X	X		
Shellac spray		X	X		
PLASTIC RESINS					
Acetone		X	X		
Dimethylaniline	X				
Natural rubbers		X	X		
Organic peroxides	X				
Resins: acrylic	X				
Resins: amino and phenolic	X				
Resins: epoxy	X				
Resins: polyester	X				
Resins: polyurethane	X				
Rubber cements: standard (hexane)	X				
Rubber cement: non flammable		X	X		



Indicates that the material is available in a product form considered to be safe for children by the California State Department of Health Services.

















SCULPTURE SAFETY CHECKLIST

ART MATERIALS OR EQUIPMENT		APPROPRIATE SAFETY EQUIPMENT		
NOT IN USE	IN USE	CORRESPONDING SAFETY EQUIPMENT AND PRACTICES	IN PLACE	NEEDED
		 GV 		
		 for mixing and sanding  vacuum or wet mop		
		 GV 		
		 GV		
				
		 GV 		
		   		
				
		 L		

SCULPTURE MATERIAL USAGE

MATERIALS	MATERIAL NOT TO BE USED	LEVELS OF MATERIAL USE			
		TEACHER	SENIOR HIGH	JUNIOR HIGH	ELEMENTARY
Rubber cement: heptane		X	X		
Silicones	X				
PLASTICS (Finished)					
Fabricating equipment: cutting drilling, sanding		X	X		
Heating equipment		X	X		
Hot wire cutter		X	X		
Plastics: acrylic (lucite, Plexiglas)		X	X		
Plastics: polyethylene		X	X		
Plastics: polypropylene		X	X		
Plastics: polystyrene (styrofoam)	X				
Plastics: polyurethane	X				
Plastics: (PVC) polyvinyl	X				
Solvent cements: acetone		X	X		
Solvent cements: chlorinated	X				
Vacuum forming equipment		X	X		
STONE					
Carving tools: hand		X	X		
Carving tools: electric		X	X		
Carving tools: pneumatic	X				

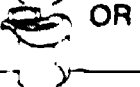













SCULPTURE SAFETY CHECKLIST

ART MATERIALS OR EQUIPMENT		APPROPRIATE SAFETY EQUIPMENT		
NOT IN USE	IN USE	CORRESPONDING SAFETY EQUIPMENT AND PRACTICES	IN PLACE	NEEDED
				
		  		
		 vacuum attachments for equipment	OR	water / air cooled tools
		vacuum or wet mop (dusts)	electrical grounding	
			low temperature settings	
				
		see process		
		↓		
		 		
		 low temperature settings	  	
		 OR	 cut away from body	downdraft ventilation
		 OR	 portable exhaust system	electrical grounding

SCULPTURE MATERIAL USAGE

MATERIALS	MATERIAL NOT TO BE USED	LEVELS OF MATERIAL USE			
		TEACHER	SENIOR HIGH	JUNIOR HIGH	ELEMENTARY
Grinding wheel		X	X		
Hard stones		X	X		
Polishing wheels		X	X		
Sanding machines		X	X		
Soft stones: asbestos containing	X				
Soft stones: asbestos free (ex. alabaster)		X	X	X	
Stone casting materials: Portland cement, sand, stone	X				
WAX					
Additives: dyes (See "Dyes" pp. 108 - 111)					
Additives: petroleum jelly		X	X	X	
Additives: rosin		X	X		
Alcohol lamps (tool warming)		X	X		
Blowpipes (tool warming)		X	X		
Sculpting tools		X	X	X	
Soldering irons (tool warming)		X	X	X	
Solvents: acetone, alcohol, benzine, mineral spirits		X	X		
Solvents: carbon, tetrachloride ether, turpentine	X				
Wax: beeswax, carnauba, ceresin, micro-crystalline wax, paraffin, tallow		X	X	X	

SCULPTURE SAFETY CHECKLIST

ART MATERIALS OR EQUIPMENT		APPROPRIATE SAFETY EQUIPMENT		
NOT IN USE	IN USE	CORRESPONDING SAFETY EQUIPMENT AND PRACTICES	IN PLACE	NEEDED
		  OR  equipment guard		
		(see soft stones below)		
		 		
		 		
		change of clothing	wet mop or vacuum	
		 		
		wet mop		
		no flammables		
		no flammables		
		no flammables		
		     self closing disposal cans		
		exhaust fans		
		double boiler	canopy hood (burnout)	
		temperature controlled hotplate with no exposed elements	OR electric frying pan	



















SCULPTURE MATERIAL USAGE

MATERIALS	MATERIAL NOT TO BE USED	LEVELS OF MATERIAL USE			
		TEACHER	SENIOR HIGH	JUNIOR HIGH	ELEMENTARY
Wax: synthetic chlorinated wax	X				
WOOD					
Bleaches: caustic soda (sodium hydroxide)	X				
Bleaches: hydrogen peroxide		X	X		
Bleaches: hydrochlorite (chlorine-type)		X	X		
Bleaches: oxalic acid	X				
Glue: casein (dry)	X				
Glue: contact adhesives (hexane)	X				
Glue: cyanocrylate (instant)		X	X		
Glue: epoxy		X	X		
Glue: formaldehyde - resin	X				
Glue: hide		X	X		
Glue: water based contact adhesive		X	X	X	
Glue: white		X	X	X	X
Lathe		X	X		
Oils (linseeds, mineral, tung)		X	X	X	X
Paint and varnish removers: methylene chloride	X				
Paint and varnish removers: toluene, xylene	X				
Shellac (denatured alcohol)		X	X		
Varnishes		X	X		



Indicates that the material is available in a product form considered to be safe for children by the California State Department of Health Services.

SCULPTURE SAFETY CHECKLIST

ART MATERIALS OR EQUIPMENT		APPROPRIATE SAFETY EQUIPMENT		
NOT IN USE	IN USE	CORRESPONDING SAFETY EQUIPMENT AND PRACTICES	IN PLACE	NEEDED
		 		
		 		
		 		
		   		
		 		
		 OR barrier cream		
		 	 equipment guards vacuum (dusts)	
				
				

Textile Arts: Hazards and Precautions

Major hazards involved in textile arts and crafts are problems in the use of dyes and the fibers themselves. **Dyes** are used for batik, yarn dyeing, fabric dyeing, painting, leather dyeing, hand made paper, and other fibers processes. For general precautions with dyes, gloves are to be worn while mixing and working with dye solutions. In the elementary school, use tea, coffee, spinach leaves, onion skins, and other natural dyes. For secondary students, use liquid dyes whenever possible.

Fine dye powders of various types can cause allergy problems and can be highly hazardous by inhalation or ingestion. Careful choice of dye type is important to reducing potential dye hazards. As dyes are often not labeled extensively, classroom instructors should use only those dyes which they are sure are safe. To reduce dusts, open dye packets underwater (with gloves) or use a glove box. A glove box can simply be prepared by using a cardboard box. The box has a glass or plexiglas top, shellacked insides (other than the top), and two armholes in the sides. Wearing gloves and using such a glove box set up is a fairly safe way to make up dye pastes. Use wet cleanup techniques as opposed to sweeping for the clean up of any dye materials.

Long term effects of many dyes are unknown and all dyes should therefore be handled with at least minimal precautions. In particular, direct dyes (azo), composed of benzidine involve numerous risks which include being carcinogens. They should never be found in the classroom.

Mordants used to set dyes can also cause problems. Potassium dichromate (suspected carcinogen) and oxalic acid are highly toxic; therefore, less toxic mordants should be chosen. McCann (1979) lists mordants and their hazards in detail on pages 344-346 of *Artist Beware*.

Fibers of all types can pose problems, especially as related to carding and spinning operations, where large amounts of dust are produced. Good ventilation is always required for activities that create large amounts of fiber dusts. Fibers should be ventilated away from the student or a dust mask is to be used during these dust producing activities. Fiber dusts can even be reduced by choosing an appropriate size needle for the yarn used in weaving experiences. Vacuuming or wet mopping, not sweeping, should be used for all cleanup procedures involving fiber materials.

Vegetable fibers should be examined for mold at the time of purchase and stored in a dry place so that molds do not form. In addition, over a period of time, dusts from these vegetable fibers can cause brown lung and other respiratory diseases in humans. Animal fibers should be disinfected so that there is no potential for the user to contract anthrax. Animal yarns and fibers that are imported should not be purchased for use in the schools because of risks of anthrax from untreated fibers. The hazards of man-made fibers are questionable. Normal precautions concerning fiber dusts should be exercised with their use.



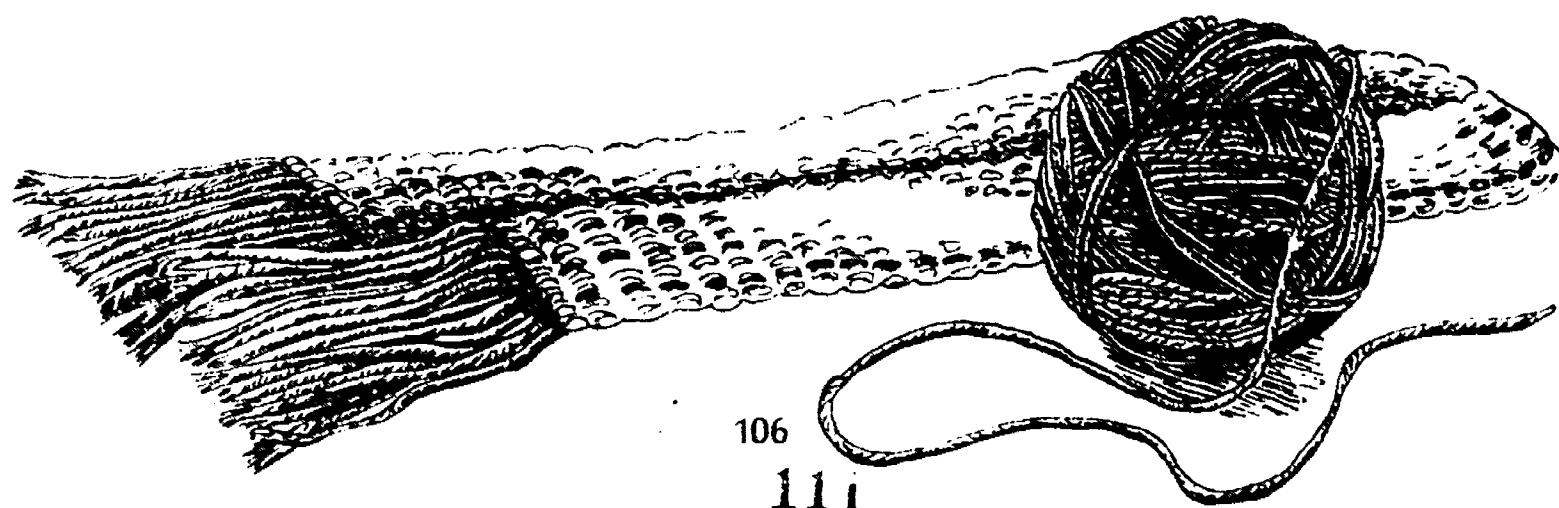















Note that many fabrics are often treated with formaldehyde resins, which can cause allergic irritations. Be alert to this problem and wash any fabrics which pose such irritation problems.



**TEXTILE ARTS
MATERIAL USAGE**

MATERIALS	MATERIAL NOT TO BE USED	LEVELS OF MATERIAL USE			
		TEACHER	SENIOR HIGH	JUNIOR HIGH	ELEMENTARY
DYES					
Acid dyes with glacial acetic acid	X				
Acid dyes with Glauber's salt (sodium sulfate)		X	X	X	
Acid dyes with sulfuric acid	X				
Acid dyes with vinegar		X	X	X	
Azoic or naphthol dyes	X				
Basic or cationic dyes		X	X	X	
Direct dyes: heat and salt, benzidine	X				
Direct dyes: heat and salt, benzidine free		X	X	X	
Dye baths		X	X	X	
Dye powders		X	X		
Fiber reactive dyes: cold water		X	X		
Lye (sodium hydroxide), caustic soda		X	X		
Mordant dyes: synthetic		X	X		
Mordants: oxalic acid, potassium dichromate	X				
Mordants: other		X	X	X	
Natural or mordant dyes		X	X	X	
Sodium carbonate	X				
Vat dyes with caustic soda, lye (sodium hydroxide)	X				
Vat dyes with chromic acid	X				

















TEXTILE ARTS SAFETY CHECKLIST

ART MATERIALS OR EQUIPMENT		APPROPRIATE SAFETY EQUIPMENT		
NOT IN USE	IN USE	CORRESPONDING SAFETY EQUIPMENT AND PRACTICES	IN PLACE	NEEDED
		 GV 		
		  for high temperatures		
		 GV   for high temperatures		
				
				
		 GV  (see also dye type)		
		glove box OR wide mouth vessel (opening underwater) wet mop or vacuum		
		glove box (powder form) 		
		  protective apron		
		 (also see "Mordants" below)		
		  OR glove box 		
		 (see also "Mordants" above)		

**TEXTILE ARTS
MATERIAL USAGE**

MATERIALS	MATERIAL NOT TO BE USED	LEVELS OF MATERIAL USE			
		TEACHER	SENIOR HIGH	JUNIOR HIGH	ELEMENTARY
Vat dyes with sodium hydrosulfite	X				
Vegetable dyes		X	X	X	X
FIBERS					
Animal fibers: hair, silk, wool, etc. - domestic		X	X	X	X
Animal fibers: imported	X				
Man made fibers: reprocessed cellulose		X	X	X	
Man made fibers: synthetic		X	X	X	
Vegetable fibers: cotton, flax, jute, hemp, sisal, etc.		X	X	X	X
MISCELLANEOUS					
Bleach (sodium hypochlorite - or household bleach for clean up	X				
Carding materials		X	X	X	
Solvents: acetone, alcohol, benzine, mineral spirits		X	X		
Solvents: carbon tetrachloride, ether, turpentine	X				
Spinning materials		X	X	X	
Tie dyeing materials		X	X	X	X
Wax: beeswax, carnauga, ceresin, micro-crystalline wax, paraffin, tallow		X	X	X	
Wax: synthetic chlorinated wax	X				
Weaving looms		X	X	X	X

TEXTILE ARTS SAFETY CHECKLIST

ART MATERIALS OR EQUIPMENT		APPROPRIATE SAFETY EQUIPMENT		
NOT IN USE	IN USE	CORRESPONDING SAFETY EQUIPMENT AND PRACTICES	IN PLACE	NEEDED
		 		
				
				
				
				
			dry storage to avoid molds  	
			vacuum or wet mop    	
		self closing disposal can	exhaust fans	
			vacuum or wet mop	
			(see also "dyes" above and previous 2 pages)	
		double boiler	canopy hood (burn out)	
		temperature controlled hot plate with no exposed elements	OR	electric frying pan
		proper ergonomics	proper lighting	

SAFETY DATA SHEETS

This section of the publication is composed of safety data sheets for students. These sheets provide key safety guidelines for specific art activities or equipment. In addition, suggestions regarding student safety quizzes on corresponding information are provided. Teachers are encouraged to photocopy these sheets and use them as a fundamental component of a safety education program in the visual arts. These sheets are not an exhaustive list of safety guidelines ; when a situation arises dealing with a specialized material, teachers should take the time to develop their own student handouts and quizzes. Some of the sheets may need to be altered to adjust the information for a specific age group.

Additional safety sheets and quizzes for industrial arts equipment (such as wood, metal, or printing equipment) may be found in the Pennsylvania Industrial Arts Safety Guide (1978).

Below, is a listing of categories contained in this section:

CERAMICS / GENERAL	113
CERAMICS / EQUIPMENT	114
COMMERCIAL ART	115
DRAWING MATERIALS	116
ENAMELING	117
GLASS / GLASSBLOWING	118
GLASS / STAINED GLASS	119
METALS / CASTING	120
METALS / CLEANING AND FINISHING	121
METALS / OXYACETYLENE WELDING	122
METALS / SOLDERING	123
PAINTING	124
PAPERCUTTER	125
PHOTOGRAPHY	126
PRINTMAKING / INTAGLIO	127
PRINTMAKING / RELIEF	129
PRINTMAKING / SILKSCREEN	130
SCULPTURE / CARVING AND FINISHING	131

CERAMICS / General : Safety Data Sheet

1. Use ceramic materials only with the instructor's permission after appropriate instructions have been given to you.
2. Chemicals and powdered materials are to be stored in covered containers.
3. Clean up using wet mop processes . Make every effort to reduce the amount of clay and glaze dusts in the workplace.
4. Do not eat, drink, or smoke in the workplace as this raises the probability of ingesting materials.
5. Use premixed clay only.
6. Wash skin and clothing frequently when working with ceramic materials.
7. Use pre-mixed lead-free glazes only.
8. Spray glazes only in a spray booth.
9. Never heat wax on an open flame; use a double boiler and temperature controlled hotplate (with no exposed elements) or an electric frying pan set on a low temperature.
10. Wear heat resistant clothing and gloves when working with a hot kiln.
11. Use kilns indoors with appropriately installed exhaust systems (canopy hood vented outdoors).
12. Check temperatures inside of the kiln through the peephole, only with appropriate infrared goggles (shades 1.7 - 3.0) which will guard against infrared damage to the eyes.
13. No flammables are to be used or stored in the kiln area.
14. Kilns should have 2 automatic shut offs : 1) a pyrometer or cone shutoff and 2) a timer. In addition, kilns should be manually checked during firing.

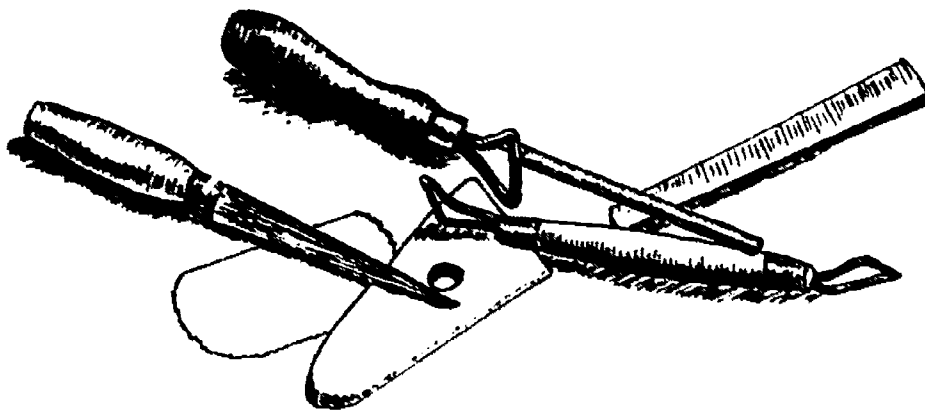

Ceramics / Equipment: Safety Data Sheet

(potter's wheels, slab rollers, extruders, pug mills)

General ceramics equipment safety

1. Use ceramics equipment only with the instructor's permission after appropriate instructions have been given to you.
2. Secure loose clothing, remove jewelry, and tie back long hair .
3. Only use ceramic equipment with safe wiring, electrical cords, and remote pedal controls.
4. Unplug electrical or pneumatic ceramic equipment when not in use.
5. Use only properly prepared clay bodies with ceramic equipment.
6. Clean up equipment and work areas using wet mop processes. Make every effort to reduce the amount of clay dusts in the workplace.

Potters wheels

7. Do not stand on fly wheels (kick type potter's wheels).

Slab rollers

8. Keep fingers clear of rollers on slab rollers at all times.

Extruders

9. Load and clean extruder barrels only when plunger locking mechanism is functioning properly.

Pug mills

10. Pug mills create large amounts of dust and therefore should not be used in school settings. Do not mix dry clay substances.

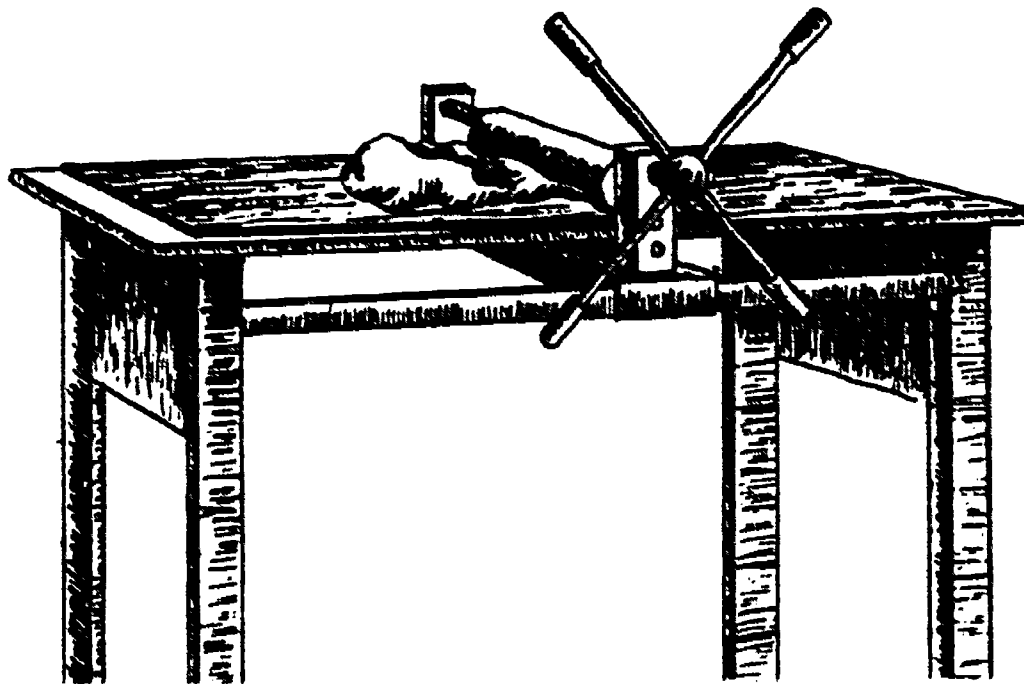

Commercial Art: Safety Data Sheet

(adhesives, airbrush, spray paint)

1. Use commercial art materials only with the instructor's permission after appropriate instructions have been given to you.
2. Do not eat, drink, or smoke in the workplace as this raises the probability of ingesting materials.

Adhesives

3. Avoid using any solvent based adhesive. Use polymer or water - based adhesives whenever possible.
4. Non-flammable or heptane-based rubber cement is to be used only with dilution or local exhaust ventilation. Avoid hexane based rubber cements.
5. The use of a hot wax applicator is a safe solution for paste-ups.

Airbrush, spray paints

6. Solvent based paints or solutions (including solvent based polymer acrylics) are not to be used in the air brush; use water-based materials.
7. Use the air brush only inside of a spray booth.
8. The use of aerosol spray paints is to be avoided. If used, spray paints are to be used in a spray booth or outdoors.

Felt tipped markers

9. Use water-based markers whenever possible. If solvent based markers, such as design or permanent markers, are used, use with extremely good ventilation (at least 10 air exchanges/hour).

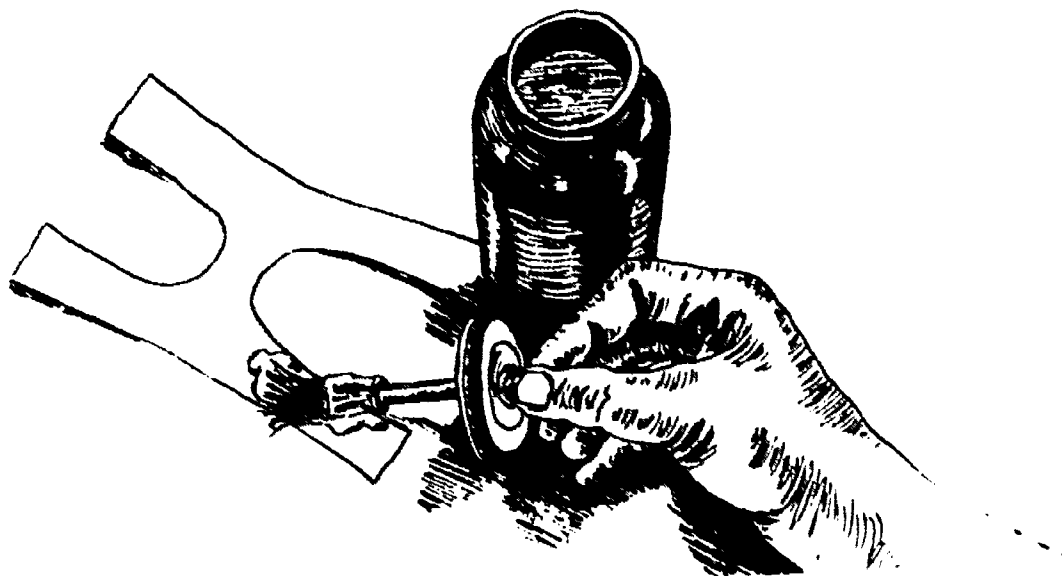

Drawing Materials: Safety Data Sheet

1. Use drawing materials only with the instructor's permission after appropriate instructions have been given to you.
2. Do not eat, drink, or smoke in the workplace as this raises the probability of ingesting materials.
3. Whenever possible, use drawing materials approved by the California State Department of Health Services.
4. Avoid using certain pigments such as lead, chromates, manganese, and cadmium which are particularly hazardous.
5. Water-based drawing inks, markers, and other drawing materials are to be used whenever possible. Solvent based materials must be used with adequate ventilation (10 air exchanges/hour). Solvent based materials are to be used in small amounts and not with an entire class.
6. Use dustless chalks whenever possible.
7. Never grind your own pigments.
8. Cleanup of dusts from chalk and charcoal should be done with wet mopping or vacuuming processes; do not sweep up dusts.
9. Many pastel pigments are toxic. Avoid blowing away excess pastel dust and cleanup with wet mopping. Use the least dusty pastels available.
10. Avoid using aerosol fixatives. They are only to be used while working outdoors or in a spray booth.

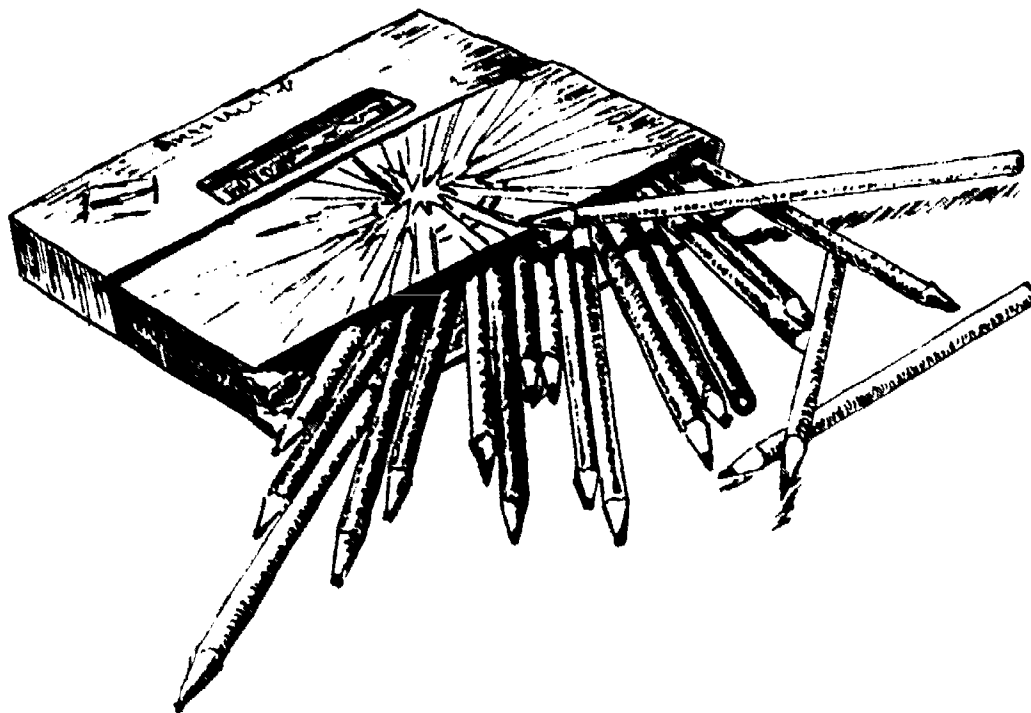

Enameling: Safety Data Sheet

1. Use enameling materials only with the instructor's permission after appropriate instructions have been given to you.
2. Do not eat, drink, or smoke in the workplace as this raises the probability of ingesting materials.
3. Remove jewelry, eliminate loose clothing, and tie back long hair before operating the enameling kiln.
4. Pickle metal with Sparex.; do not use acids. Wear safety goggles and gloves for the cleaning operation.
5. Do not grind your own enamels.
6. Use only lead-free enamels.
7. When applying enamels by dusting, execute this process inside of a fume hood or spray booth. Avoid spraying enamel solutions on the metal surface; if sprayed, do so only in a spray booth.
8. Use solvents only while wearing gloves and goggles
9. Dispose of solvent-soaked rags and towels in a self-closing safety disposal container.
10. No flammables are to be stored or used in the kiln area.
11. Enameling kiln operation is to be conducted using leather gloves and tongs.
12. Use kilns indoors with appropriately installed exhaust systems (canopy hood or window exhaust fan).
13. Use infrared goggles (shade #1.7 - 3.0) when looking into the enameling kiln.
14. Wet mop for clean up, do not sweep.

Glass / Glassblowing: Safety Data Sheet

1. Use glassblowing materials only with the instructor's permission after appropriate instructions have been given to you.
2. Do not eat, drink, or smoke in the workplace as this raises the probability of ingesting materials.
3. Remove jewelry, eliminate loose clothing, and tie back long hair before operating the enameling kiln.
4. Do not use chemical powders or prepare your own glass mixtures.
5. Use cullets or second melts to reduce hazards.
6. Decorate glass by dipping, or painting. Do not spray decoration on glass because of inhalation hazards.
7. Furnaces and annealing ovens are to be used with infrared barriers, goggles, and personal protective clothing.
8. Furnaces are to only be operated with local exhaust ventilation.
9. For lampworking techniques, torch work done with oxyacetylene or propane is to be ventilated with local exhaust ventilation.
10. Goggles are to be worn while using any cutting or finishing machines with glass.
11. Do not use hydrofluoric acid for etching processes; use fluoride pastes for these processes while wearing gloves and goggles.

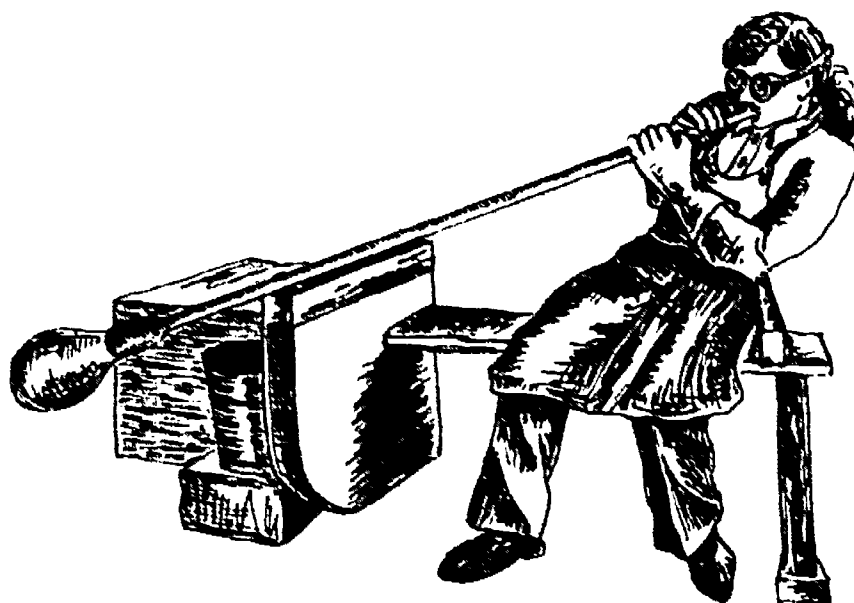

Glass / Stained Glass: Safety Data Sheet

1. Use stained glass materials only with the instructor's permission after appropriate instructions have been given to you.
2. Do not eat, drink, or smoke in the workplace as this raises the probability of ingesting materials.
3. Remove jewelry, eliminate loose clothing, and tie back long hair before operating the enameling kiln.
4. Use cutting tools or grazing pliers with goggles.
5. Handle sharp edges with care; use protective gloves.
6. Wet mop for clean up; do not sweep.
7. Lead came must be handled with careful hygiene and cleanup procedures because of injection hazards. Use wet mopping for clean up .
8. Soldering operations are to be done using local exhaust ventilation.
9. Do not use acid or zinc chloride fluxes for soldering operations.

Grinding

10. Smooth sharp glass edges on the grinding wheel or with abrasive paper. Use wet grinding processes to help avoid dust problems
11. Operate grinder and buffer only when safety shields and wheel guards are in place.
12. Wear goggles or faceshield when using grinder or buffer.
13. Stand to the side when starting the grinder or buffer.
14. Hold small pieces of work to be machined with vise grip type pliers.
15. Wait for machine to totally stop before leaving the equipment.
16. Operate grinder with tool rest 1/16" away from the grinding wheel. Do not use the side of the grinding wheel.

Metals / Casting: Safety Data Sheet

1. Use casting materials only with the instructor's permission after appropriate instructions have been given to you.
2. Do not eat, drink, or smoke in the workplace as this raises the probability of ingesting materials.
3. Remove jewelry, eliminate loose clothing, and tie back long hair.
4. During the melting and pouring operations of metals, metal fumes are to be vented with local exhaust ventilation.
5. Use wet mopping to clean up investment dusts; do not sweep.

Centrifuge casting

6. Use powdered pumice, plaster, or other non-silica investments. Do not use asbestos or silica investment plasters.
7. Burnout kilns are to be used under a canopy hood.
8. Wear protective goggles when using centrifuge.
9. Obtain detailed instructions from your instructor on using the torch to heat your metal.
10. Keep casting area clear when centrifuge is released.

Foundry casting

11. Use foundry sands; do not use silica sands or resin binders.
12. For protection from heat during casting, wear infrared goggles, protective clothing (gloves, coat, shoes, leg protectors), and a face shield (for infrared radiation).
13. Use tongs to place metal in the crucible.
14. When pouring, keep metal close to the floor and move slowly. Pouring operations are to be executed with local exhaust ventilation.
15. Do not step on metal spilled on the floor.

Metals / Cleaning and Finishing: Safety Data Sheet

(surface manipulation, finishing, buffing & grinding)

1. Use metal cleaning and finishing materials only with the instructor's permission after appropriate instructions have been given to you.
2. Do not eat, drink, or smoke in the workplace as this raises the probability of ingesting materials.
3. Remove jewelry, eliminate loose clothing, and tie back long hair.
4. Use sparex rather than acids or potassium dichromate for finishing processes.
5. Wear goggles and gloves when working with sparex.
6. Always use engraving tools for repousse and chasing with tool cutting away from you.
7. Apply colorants by paste, dipping, or brushing. Check individual hazards of the material to be used.

Grinding and buffing

8. Operate grinder and buffer only when safety shields and wheel guards are in place.
9. Remove grinding and buffing dusts with local exhaust ventilation.
10. For eye protection, wear goggles or face shield when using grinder/buffer.
11. Stand to the side when starting the grinder or buffer.
12. Hold small pieces of work to be machined with vise grip type pliers.
13. Wait for machine to totally stop before leaving the equipment.
14. Do not buff or grind any type of chain.
15. Operate grinder with tool rest 1/16" away from the grinding wheel. Do not use the side of the grinding wheel.

Metals / Oxyacetylene Welding: Safety Data Sheets

1. Use welding equipment and materials only with the instructor's permission after appropriate instructions have been given to you.
2. Do not eat, drink, or smoke in the workplace as this raises the probability of ingesting materials.
3. Remove jewelry, eliminate loose clothing, and tie back long hair.
4. No flammables are to be used or stored in the welding area.
5. Secure oxygen and acetylene tanks with chain or other similar device. Store oxygen and acetylene tanks separately.
6. Keep oil and grease away from oxygen cylinders and valves. A combination of oxygen and oil or grease may cause an explosion.
7. Use oxygen and acetylene cylinders only with pressure-reducing regulators. Never use acetylene in excess of 15 *psi*.
8. Keep the wrench in place on the valve stem, which is used to open the cylinder valve.
9. Open cylinders gradually.
10. Before lighting the torch, always check the pressure on the regulators.
11. Welding is to be done only on fireproof work surfaces.
12. Protect hoses and cylinders from open flames.
13. Operate welding equipment with local exhaust ventilation.
14. Wear protective clothing and goggles (shade #4 to 8).
15. Turn off torch valves when finished with equipment. Turn off gas and oxygen at tanks or stations at the end of class.

Metals / Soldering: Safety Data Sheet

1. Use soldering equipment and materials only with the instructor's permission after appropriate instructions have been given to you.
2. Do not eat, drink, or smoke in the workplace as this raises the probability of ingesting materials.
3. Remove jewelry, eliminate loose clothing, and tie back long hair.
4. Wear protective goggles (at least shade #4) appropriate to temperature of soldering.
5. Operate soldering equipment with local exhaust ventilation.
6. Do not use cadmium containing solders, or zinc chloride or fluoride fluxes due to highly toxic fumes.
7. Soldering irons are to be in good electrical repair with no loose wiring.
8. Use oxyacetylene only after in-depth instruction from your instructor.
9. Use friction torch lighter to ignite torch or portable propane cylinder unit.
10. No flammables are to be used or stored in the soldering area.
11. Fasten all portable propane cylinders used in soldering operations in place.



Painting: Safety Data Sheet

1. Use painting materials only with the instructor's permission after appropriate instructions have been given to you.
2. Do not eat, drink, or smoke in the workplace as this raises the probability of ingesting materials.
3. Whenever possible, use painting materials approved by the California State Department of Health Services.
4. Avoid using certain pigments such as lead, chromates, manganese, and cadmium, which are particularly hazardous.
5. Never grind your own pigments.
6. Do not use fresco or epoxy painting techniques in schools, as they involve highly toxic materials.
7. Do not use ammonium hydroxide or tetrachloroethane when working with casein.
8. Use a double boiler and temperature controlled hotplate or electric frying pan for melting wax for encaustic painting processes.
9. Avoid using oil paints; use water-based paints. If oil paints are used, limit the number of students and have a well ventilated work area.
10. If working with oils, use turpentine substitute rather than turpentine to act as a drier for the paints.
11. Dispose of oil and solvent soaked rags and towels in a self-closing safety disposal container.
12. Use the least toxic solvent for painting and clean up processes. For example, use mineral spirits to clean up oil paints.
13. Use baby oil (followed by soap and water) to clean oil based paints from the hands.

Papercutter: Safety Data Sheet

1. Use the papercutter only with the instructor's permission; after appropriate instructions have been given to you.
2. Secure loose clothing, remove jewelry, and tie back long hair.
3. Cutter guard must be in place.
4. No one is to stand behind or directly next to an individual using the paper cutter.
5. Unlock blade latch before use; lock latch after use. Never leave blade in an open position.
6. Handle on blade arm should be operated by the arm on that side of the body (usually the right side on most cutters).
7. Hand holding the paper on the gridded working surface of the cutter should be no closer than 3" to the blade.
8. Cut paper of appropriate thickness for the equipment. Do not force the blade on thick stock.
9. Floor and table area around the machine must be cleaned of trimmings and other supplies/ equipment.

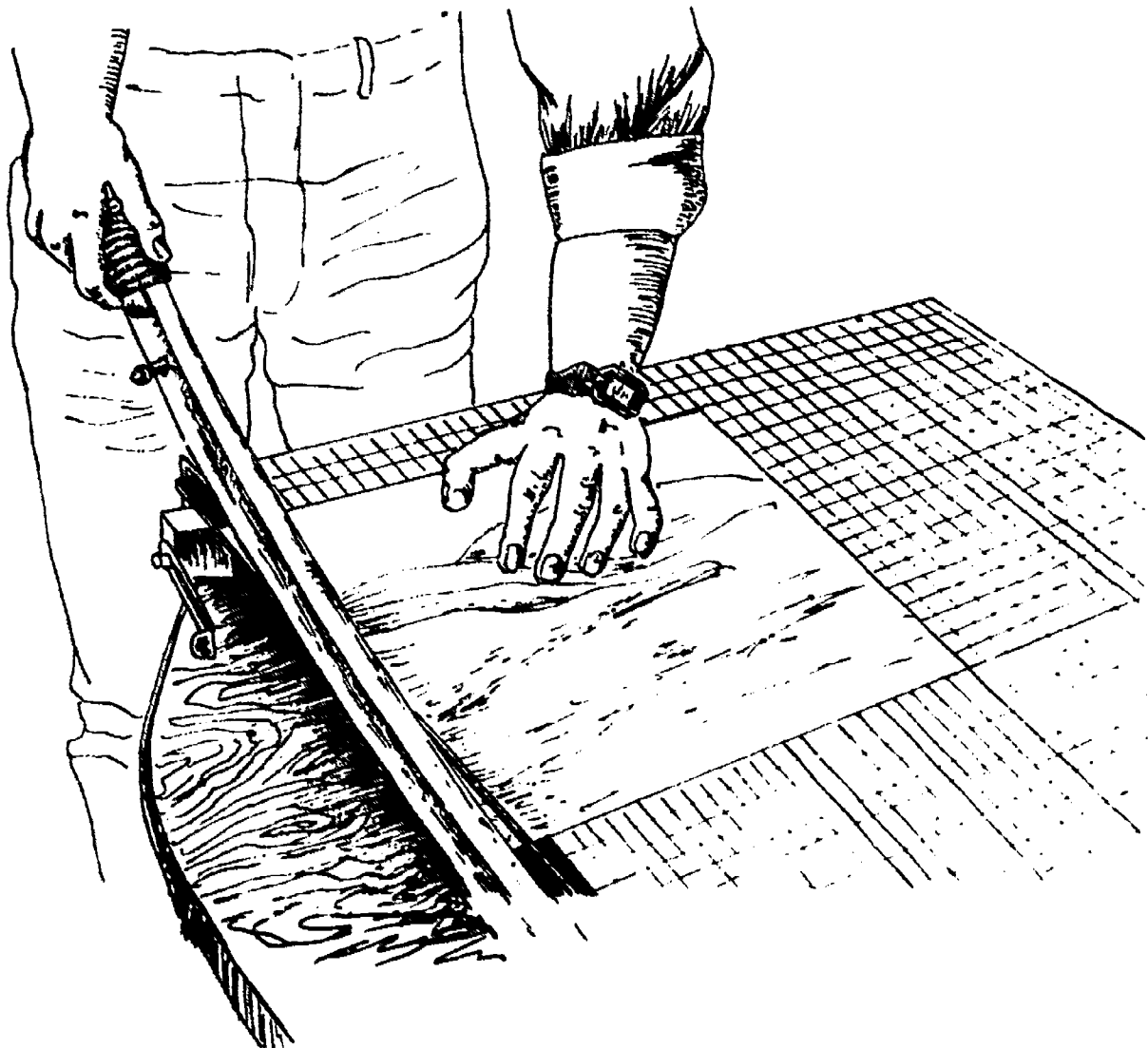

Photography: Safety Data Sheet

1. Use photography equipment and materials only with the instructor's permission after appropriate instructions have been given to you.
2. Do not eat, drink, or smoke in the workplace as this raises the probability of ingesting materials.
3. Remove jewelry, eliminate loose clothing , and tie back long hair.
4. Use tongs with all chemical baths.
5. Black and white chemical baths should be ventilated with dilution ventilation (20 air exchanges/ hour).
6. Cover chemical baths when not in use.
7. Use eye wash station to treat chemical splashes in the eyes.
8. Check individual mixing precautions before mixing stock solutions from powders or concentrates. Mix chemicals where an emergency shower is available.
9. Avoid using highly toxic intensifiers and reducers with negatives.
10. Use toners such as sepia toner, with local exhaust ventilation..

Color

11. Local exhaust ventilation is essential to safe use of color chemicals.
12. Special color processes may require gloves and other protective clothing.

Alternative processes

13. Do not use only carbon arc lamps. Use other artificial lighting or use natural sunlight for exposures in the open air.
14. When using liquid emulsions, always handle these solutions with goggles, gloves, and a protective apron.
15. Some alternative processes may require gloves for the developing process.

Printmaking / Intaglio: Safety Data Sheet

1. Use intaglio equipment and materials only with the instructor's permission after appropriate instructions have been given to you.
2. Do not eat, drink, or smoke in the workplace as this raises the probability of ingesting materials.
3. Remove jewelry, eliminate loose clothing, and tie back long hair.
4. Cutting tools used in engraving and drypoint are to be used with tools cutting away from the body and hands.
5. Rosin is explosive in an enclosed space. Use spark proof rosin boxes.

Printing press

6. Use printing press only after in-depth instruction from your instructor.
7. Do not make adjustments while the press is in operation. Never place fingers near or under rollers.
8. Operate the press with only one individual at a time.

Acids

9. Wear rubber gloves, goggles, and protective clothing when etching or aquatinting metal plates in the acid bath.
10. Acid baths are to be used with an emergency shower available nearby.
11. Acid bath is to be properly vented outdoors with a fume hood.
12. When diluting acids, always add the acid to the water, never the reverse.
13. Sodium bicarbonate (baking soda) is the neutralizing agent to be used for acids in the case of an emergency.
14. Acid baths are to be totally covered or returned to the storage bottle when not in use.

Solvents

15. Use self-closing safety disposal containers for all rags and paper materials. These containers should be emptied every night.
16. Use solvents in a well ventilated room.
17. Plate cleaning must be done with local exhaust ventilation.
18. No open flames in the solvent area.

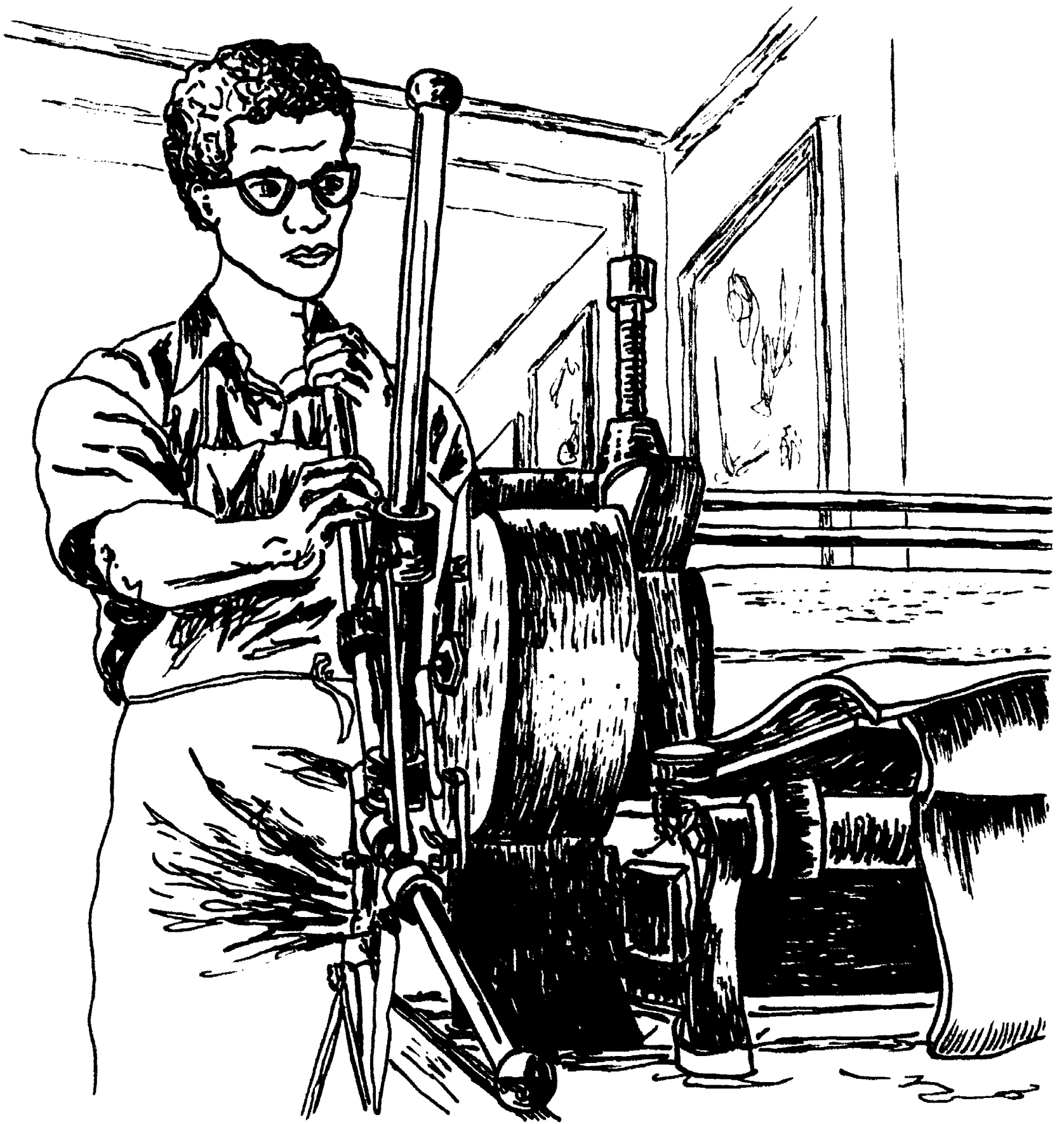

Printmaking / Relief: Safety Data Sheet

1. Use relief printing materials and equipment only with the instructor's permission after appropriate instructions have been given to you.
2. Do not eat, drink, or smoke in the workplace as this raises the probability of ingesting materials.
3. Use cutting tools only with tools pointing away from the body and hands.
4. Whenever possible, use water soluble inks approved by the California State Department of Health Services.

Printing press

5. Use printing press only after in-depth instruction from your instructor.
6. Secure loose clothing, remove jewelry, and tie back long hair.
7. Do not make adjustments while the press is in operation.
8. Never place fingers near or under rollers.
9. Operate the press with only one individual at a time.

Collagraphs

10. Use only water-based glues for collagraphs, do not use solvent based glues.
11. Seal collagraph surfaces with acrylic applied with a brush. Do not spray fixative to seal the collagraph surface.
12. If necessary to sand collagraph surfaces, do this operation in a fume hood.

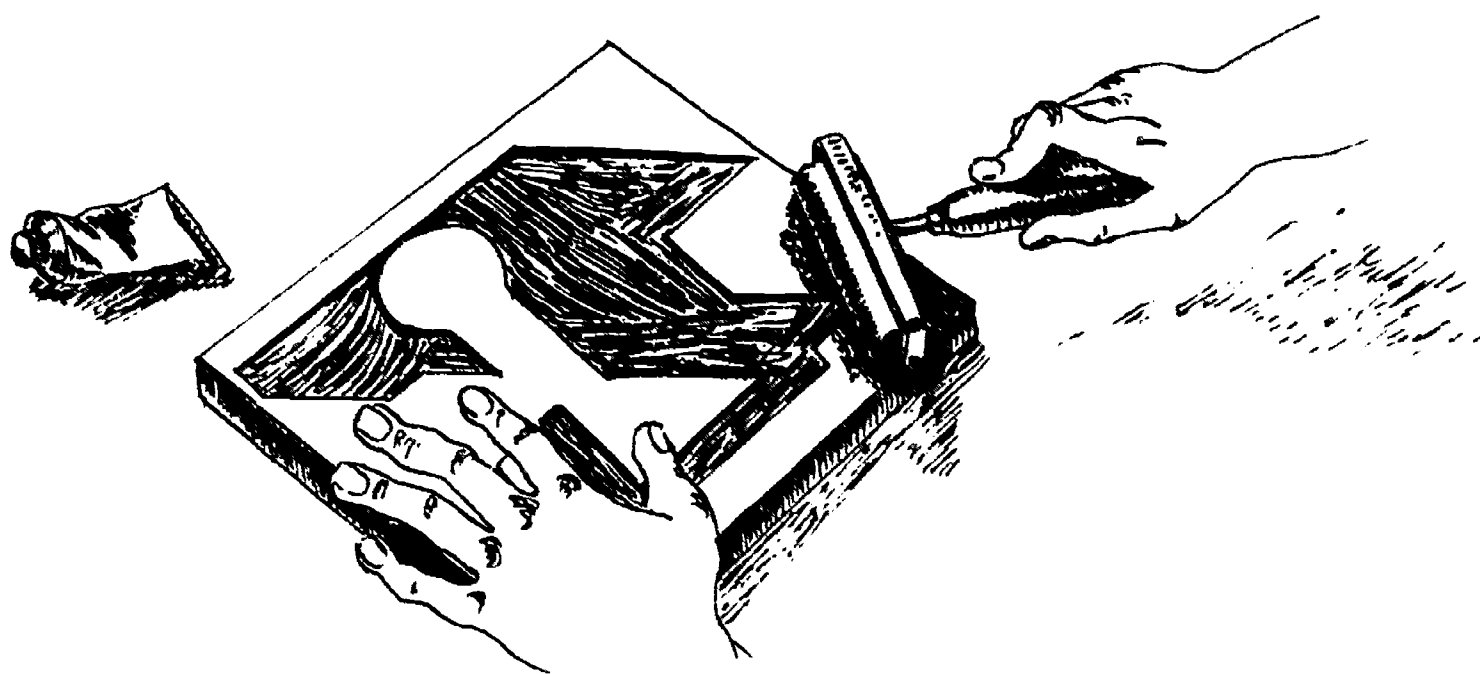

Printmaking / Silkscreening: Safety Data Sheet

1. Use silkscreening materials and equipment only with the instructor's permission after appropriate instructions have been given to you.
2. Do not eat, drink, or smoke in the workplace as this raises the probability of ingesting materials.
3. Use only water based or acrylic inks approved by the California State Department of Health Services.
4. Do not use epoxy, poster, or vinyl inks because of skin and inhalation hazards.
5. Do not use commercial wash-ups . They can only be used safely in a fume hood.
6. Use diazo photo emulsions, paper stencils, thermofax stencils, or friskets applied in reverse whenever possible.
7. Lacquer thinners are highly toxic by inhalation. Do not use lacquer thinners and lacquer stencils as they can only be used in a fume hood .

Solvents

8. Store solvents in appropriate safety containers.
9. Use self-closing safety disposal containers for all rags and paper materials. These containers should be emptied every night.
10. No open flames in the solvent area.

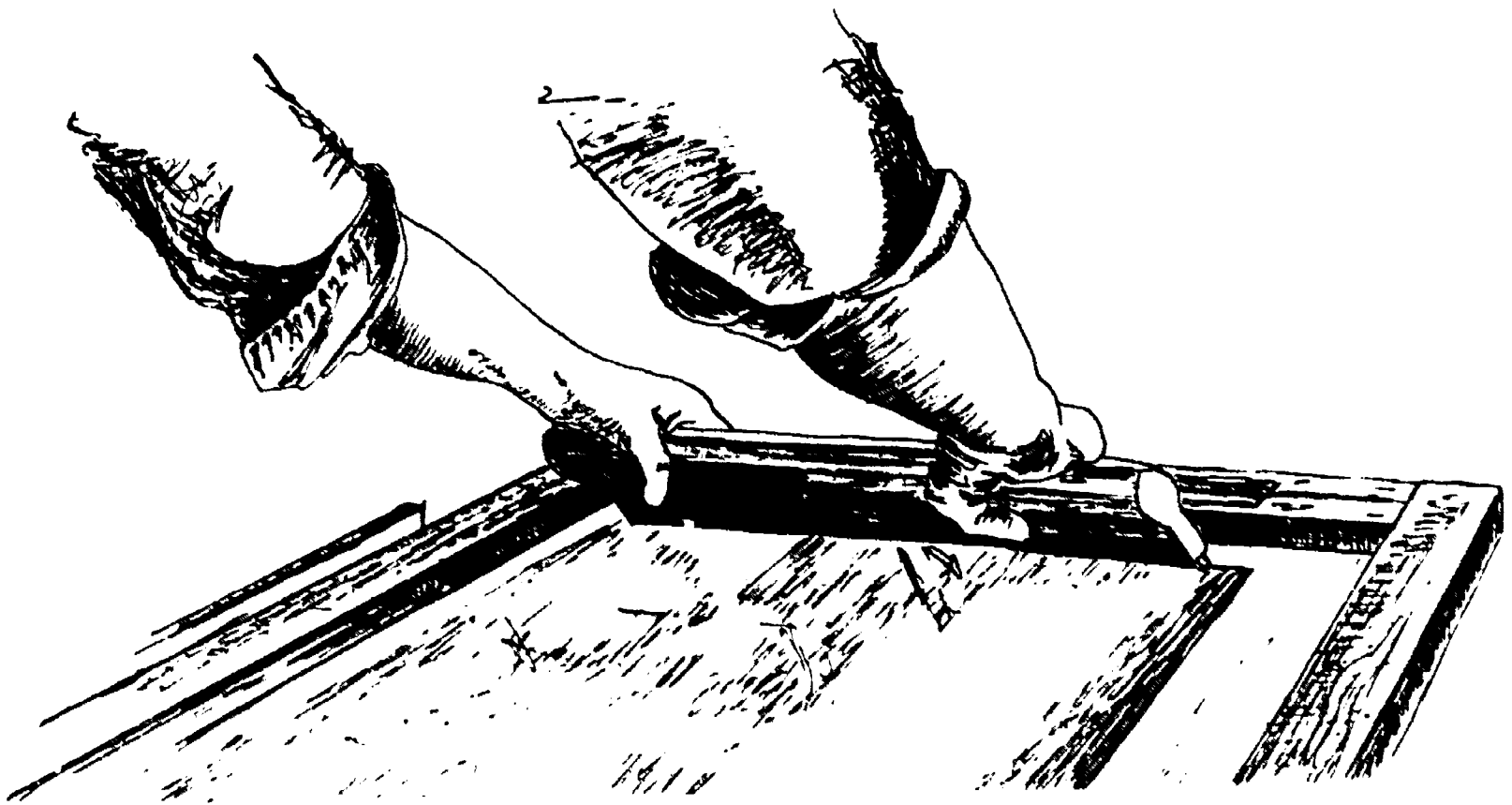

Sculpture / Carving and Finishing: Safety Data Sheet

1. Use sculpture equipment and materials only with the instructor's permission after appropriate instructions have been given to you.
2. Do not eat, drink, or smoke in the workplace as this raises the probability of ingesting materials.
3. Remove jewelry, eliminate loose clothing, and tie back long hair.
4. Always use safety goggles when carving or working in the carving area.
5. Use wet mopping or vacuuming for all clean up processes; do not sweep.
6. Finish sculptures with brush techniques; do not spray finishes or use powdered pigments.

Plaster

7. Use a dust mask when mixing or sanding plaster.
8. Do not use sand, silica sands or vermiculite for plaster additives because they are an inhalation hazard.
9. Use mineral oil, petroleum jelly, green soap, or vaseline for mold releases.

Plastics

10. No plastic resins are to be used in the classroom as they are highly toxic.
11. When fabricating finished plastics, use local exhaust ventilation to remove toxic fumes which are produced through heat decomposition.

Stone

12. Check stone composition for toxic minerals. Use asbestos free stones.
13. Pneumatic tools are not to be used in the school setting due to vibration, intense noise, and huge amounts of dust.

Wood

14. Use non-toxic or water-based glues; do not use solvent-based glues.
15. Use natural oil finishes; do not use spray finishes (inhalation hazard).

Student competency with specific materials or equipment should be tested before the student actually uses materials which could pose potential hazards. Students should have to qualify for using specialized equipment and not assume that because they registered for a class, that they will be using whatever equipment they want. A department or teacher designed materials quiz should include pertinent information related to the student's responsibilities and ability level. Quizzes that are short essay or completion are often more appropriate than multiple choice or matching questions because students will not be able to simply guess at the correct answers. It is recognized that due to teacher work load, it may be necessary to give quizzes which can be corrected fairly quickly.

In addition to the quiz, student ability to safely operate a piece of equipment should be examined; for organizational purposes, it is probably easiest to provide a place on the quiz form for the teacher to document this practical examination. For liability purposes, these quizzes should be kept on file; be sure to include the student name, date, and teacher name on each quiz form. A sample quiz follows.



Sample Quiz ceramics

Student name: _____

Date: _____

Teacher name _____

1. What are the hazards of ceramic clay and glaze dusts?
2. What steps can be taken to reduce the hazards of these ceramic dusts?
 - A.
 - B.
 - C.
 - D.
3. When spraying glazes, use _____.
4. Wax should only be heated _____.
5. Fumes from kilns are best removed by using _____.
6. To safely check the temperature inside the kiln through the peephole, an individual must _____.

Teacher Approval / Practical Exam

_____ (signature)

_____ (date)

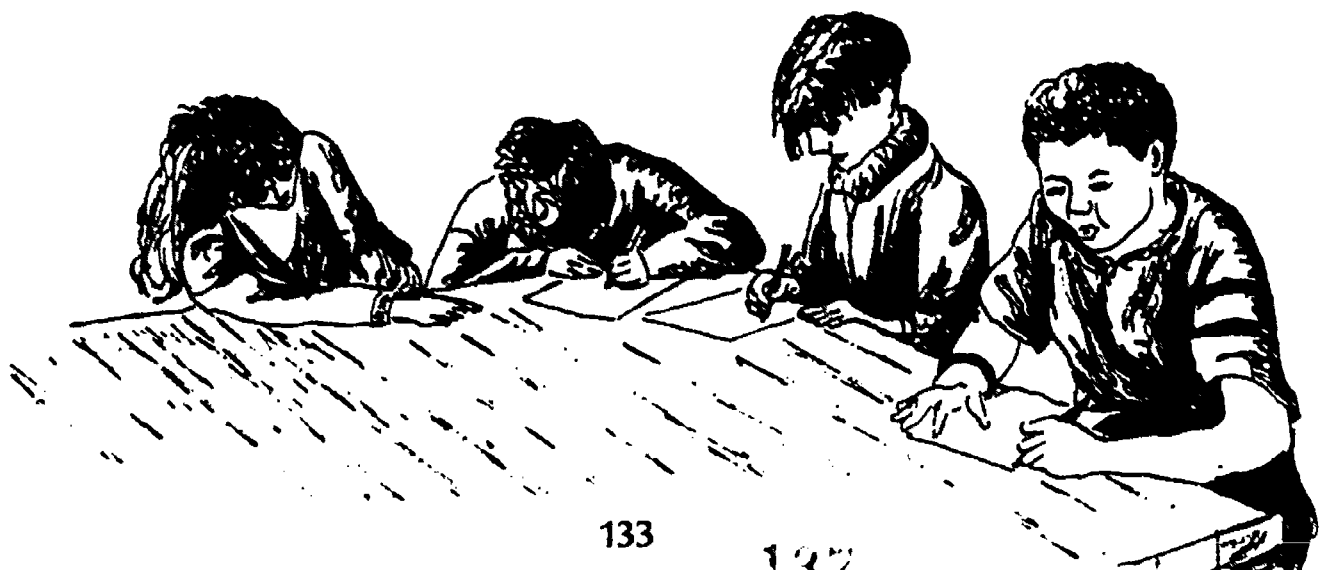

RESOURCES

CALIFORNIA STATE DEPARTMENT OF HEALTH SERVICES - PRODUCT LISTING

available from:

Center for Safety in the Arts
5 Beekman Street; Suite 1030
New York, N.Y. 10038

EDUCATIONAL MATERIALS

Health and Safety Referral Service
American Chemical Society
1155 Sixteenth Street, N.W.
Washington, D.C. 20036
(202)872-4511

National Safety Council
444 North Michigan Avenue
Chicago, IL. 60611

GENERAL SAFETY SUPPLY *

Conney Safety Products
3202 Latham Drive
P.O. Box 4190
Madison, WI. 53711
1-800-356-9100

Delaware Valley Safeguards Co., Inc.
R.D. #1 Leisz Road off Route 183
Leesport, PA. 19533
(215)926-5232

Direct Safety Company
7815 South 46th Street
Phoenix, AZ. 85044
1-800-528-7405

Fisher Scientific
Educational Materials Division
4901 W. LeMoyné Street
Chicago, IL. 60651
1-800-621-4769

Henry's Safety Supply Co.
P.O. Box 30277
Billings, MT. 59107

Industrial Safety and Security Co.
1390 Neubrecht Road
Lima, OH. 45801

Lab Safety Supply
P.O. Box 1368
Janesville, WI. 53547-1368
1-800-356-0783

Leonard Safety Equipment
253 Waterman Ave./P.O. Box 4344
East Providence, RI. 02914
1-800-556-7170

The Pavlik Company
554 Green Bay Road
Kenilworth, IL. 60043

Sargent-Welch
9520 Midwest Ave.
Garfield Heights
Cleveland, OH. 44125

GOVERNMENT AGENCIES

(CPSC) Consumer Product Safety Commission
1111 Eighteenth Street NW.
Washington, D.C. 20207
(202) 634-7790

(EPA) Environmental Protection Agency
401 M. Street SW
Washington, D.C. 20460
(202) 382-2090

Government Printing Office
North Capitol and H Streets NW.
Washington, D.C. 20401
(202) 275-2051

(OSHA) Occupational Safety and Health
Administration
Department of Labor
3535 Market Street
Philadelphia, PA. 19104
(215) 596-1201 (regional office)

Right to Know Office
Room 1404 Labor and Industry Building
7th and Forster Streets
Harrisburg, PA. 17120
(717) 783-2071

Center for Safety in the Arts (CSA)
5 Beekman Street; Suite 1030
New York, NY 10038
(212) 227-6220

Hazards in the Arts
5340 N. Magnolia
Chicago, Illinois 60640

National Resources Defense Council
122 E. 42nd Street
New York, New York 10017
(children's art hazards booklet)

LABELS

Safety Rules Inc.
3727 Joan Drive
Waterloo, IA. 50702
1-800-641-5466

Seton Name Plate Corporation
P.O. Drawer FE-1331
New Haven, CT. 06505
1-800-243-6624

ORGANIZATIONS - HEALTH HAZARDS AND ART MATERIALS

Art & Craft Materials Institute
715 Boylston Street
Boston, MA 02116
(617) 226-6800

ORGANIZATIONS - STANDARDS

(ANSI) American National Standards Institute
655 15th Street., N.W.
Suite 300
Washington, D.C. 20005
(202) 639-4090

(NFPA) National Fire Protection Association
Batterymarch Park
Quincy, MA 02269
(617) 770-3000

VENTILATION EQUIPMENT*

Lab Safety Supply
P.O. Box 1368
Janesville, WI. 53547-1368
1-800-356-0783

* A more extensive list of suppliers in your area may readily be found in a Business to Business telephone directory indexed under "Ventilating Equipment" and "Safety Equipment and Clothing." The above list of manufactures is not to be considered complete, but rather a starting point for the educator.

GLOSSARY

Acute illnesses: resulting from single exposures to toxic chemicals; usually the effects are immediate

Additive effect: two or more substances attack the same part of the body with a combined effect that is the sum of the two separate exposures

Approved product (AP): certified by the Art and Craft Materials Institute to contain no materials in sufficient quantities to be toxic or injurious to the body, even if ingested

Chronic illnesses: resulting from prolonged and repeated exposure to toxic chemicals; effect may take years to appear

Combustible: all liquids with a flash point at or above 100° F

Certified product (CP): certified by the Art and Craft Materials Institute to meet AP requirements and standards of workmanship, working qualities, color, and other standards

Flammable: all liquids with a flash point below 100° F

Dilution ventilation: general ventilation used to dilute toxic solvent vapors

Dusts: particles produced by grinding, crushing, and other handling

Fumes: solid particles formed above molten metal

Health label (HL): product seal of the Art and Craft Materials Institute; this "cautions required" seal indicates that the product contains a toxic ingredient and is certified to carry specific labeling as required by the institute's toxicologist

Ingestion: toxins enter the body by the mouth through activities including eating, drinking, and smoking, and are then ingested

Inhalation: toxins enter the body through the respiratory system

Local ventilation: ventilation system such as a canopy hood, vent or fan, that allows toxins to be pulled away from individuals and to be exhausted outside of the building

Material Safety Data Sheet (MSDS): forms available from manufacturers which list product information including product and manufacturer, hazardous ingredients, physical data, fire and explosion data, health hazard data, reactivity data, spill or leak procedures, special protection information, and special precautions

Mists: droplets which become airborne through various processes; are also formed from liquids at room temperature, i.e. acid mist

Non-toxic: term regulated by the Federal Hazardous Substances Act which identifies products which are acutely toxic for adults (not children); term is often misused on product labels for art materials. Properly used, the term does not mean that the product is safe to eat.

Skin contact: toxins are absorbed through the skin and eyes

Solvent: liquids which can dissolve other materials

Synergistic effect: combined effect of chemicals in which the resulting effects are far more damaging than either individual material; a multiplying effect

Total body burden: cumulative effect of separate exposures to a chemical

Toxic: poisonous (see "toxin" below)

Toxicology: study of the effects of toxic or poisonous substances on living organisms

Toxin: poison; a substance which enters the body in a quality that exceeds the body's capacity to handle the material. It may enter the body through skin contact, inhalation, & ingestion.

Vapors: gaseous forms of substances which are normally in a liquid or solid state



BIBLIOGRAPHY

- Allaince of American Insurers. (1980) *Handbook of Organic Industrial Solvents*, 5th ed. Chicago, Illinois.
- Clark, N., Cutter, T., McGrane, J. (1984). *Ventilation: A Practical Guide*. New York: Center for Safety in the Arts.
- Kulasiewicz, F. (1974). *Glassblowing*. New York: Watson-Guptill Publications.
- McCann, M. (1979). *Artist Beware*. New York: Watson-Guptill Publications.
- McCann, M. (1978). Impact of Hazards in Art on Female Workers, *Preventive Medicine*, 7, 338.
- McCann, M. (1986). *Reproductive Hazards in the Arts and Crafts*. New York: Center for Safety in the Arts.
- McCann, M. (1987). *Teaching Art Safety to the Disabled*. New York: Center for Safety in the Arts.
- National Institute of Occupational Safety and Health. (1973). *The Industrial Environment—Its Evaluation and Control*. Washington: U.S. Government Printing Office.
- Pennsylvania Department of Labor and Industry. (1984, October 5). *Worker and Community Right to Know Act 1984-159*.
- Qualley, C. (1986). *Safety in the Artroom*. Worcester, Massachusetts: Davis Publications.
- Quinn, M., Smith, S., Stock, L., Young, J. (1980). *What You Should Know About Health and Safety in the Jewelry Industry*. Providence, R.I.: Jewelry Workers Health and Safety Research Group.
- Seeger, N. (1982). *A Ceramist's Guide to the Safe Use of Materials*. Chicago: The Art Institute of Chicago.
- Seeger, N. (1982). *A Painter's Guide to the Safe Use of Materials*. Chicago: The Art Institute of Chicago.
- Shaw, S. (1983). *Over Exposure: Health Hazards in Photography*. California: Friends of Photography.
- Siedlecki, J. (1972, February). "Potential Hazards of Plastics Used in Sculpture." *Journal of the National Art Education Association*. Vol.25.
- U.S. Department of Labor. (1974, June 27). *Occupational Safety and Health Standards*. Federal Register.
- U.S. Government. (1972, October 27). *Consumer Product Safety Act. Public Law 92-573*.
- U.S. Government. (1970, December 29). *Occupational Safety and Health Act. Public Law 91-596*.
- U.S. Government. (1976, October 11). *Toxic Substances Control Act. Public Law 94-469*.

Quick Reference Guide Safety Equipment ICONS

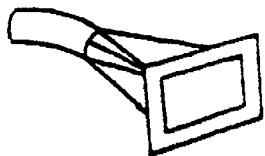

VENTILATION

GV - good general ventilation

L - local exhaust ventilation

C - canopy hood unit

P - portable exhaust unit

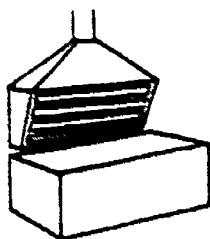

SLOT HOOD

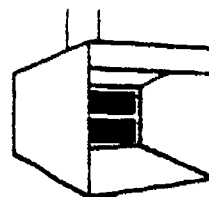

SPRAY BOOTH



HOODED VENTILATED GOOGLES



SAFETY GLASSES



FACESHIELD



WELDING GOOGLES

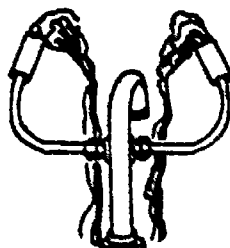

EYE WASH STATION

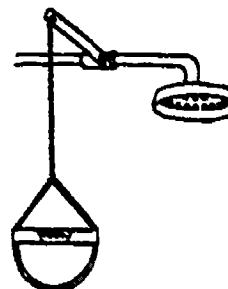

EMERGENCY SHOWER

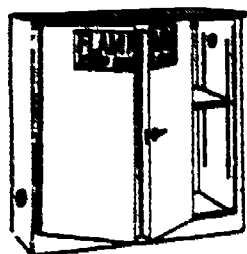

APPROVED FLAMMABLE STORAGE CABINET



SAFETY STORAGE CONTAINERS

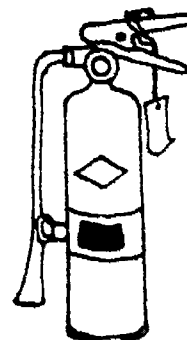

FIRE EXTINGUISHER



RESPIRATOR

O - organic vapor

A - acid gas

D - dust

(all NIOSH approved)

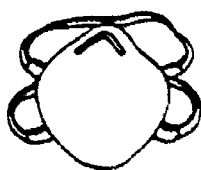

DUST MASK (2 straps)



GLOVES

N - neoprene

TH - thermal

LE - leather

C - cotton

L - latex



NO OPEN FLAMES